



Annual Report 2019



**ICAR-Central Institute for Research on Cotton Technology
Mumbai**

Towards Doubling Farmer's Income through Sustainable Cotton Processing Technologies & Value Addition to by-produce



ICAR-CIRCOT

ANNUAL REPORT 2019



ISO 9001:2015

ICAR-Central Institute for Research on Cotton Technology

Adenwala Road, Matunga (East), Mumbai-400 019

(An ISO 9001:2015 Certified Institute and NABL Accredited Lab)

www.circot.res.in

ICAR-CIRCOT Annual Report 2019

Published by

Dr. P. G. Patil, Director

Compiled by

Narayanan K.
Anand R. Jadhav
Hemangi R. Pednekar

Edited by

Dr. P. G. Patil
Dr. A. S. M. Raja
Dr. N. Vigneshwaran
Dr. A. K. Bharimalla
Dr. C. Sundaramoorthy

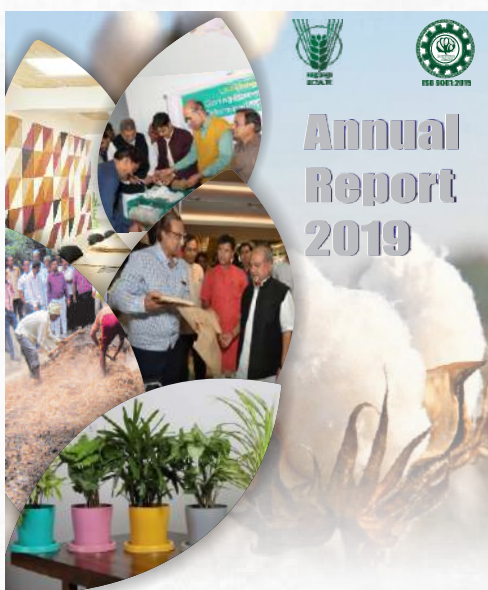

ICAR-Central Institute for Research on Cotton Technology
Mumbai

Towards Doubling Farmer's Income through Sustainable Cotton Processing Technologies & Value Addition to by-products

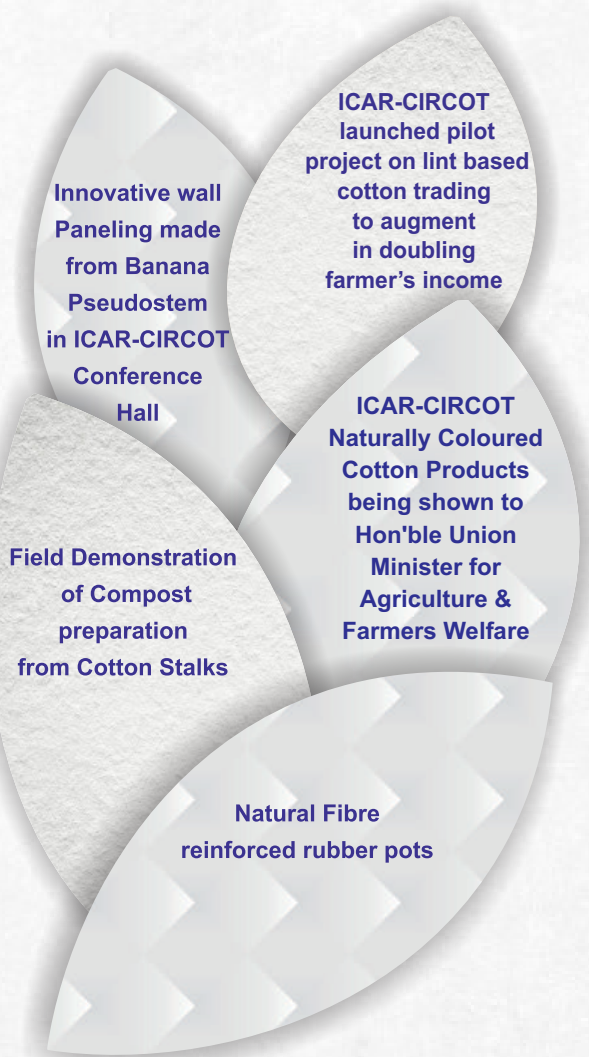

Innovative wall
Paneling made
from Banana
Pseudostem
in ICAR-CIRCOT
Conference
Hall

ICAR-CIRCOT
launched pilot
project on lint based
cotton trading
to augment
in doubling
farmer's income

ICAR-CIRCOT
Naturally Coloured
Cotton Products
being shown to
Hon'ble Union
Minister for
Agriculture &
Farmers Welfare

Field Demonstration
of Compost
preparation
from Cotton Stalks

Natural Fibre
reinforced rubber pots

Cover: Collage of Institute Activities

Cover page Design: Mrs. Laxmi Manoj Singh

Printed at Colour Count, Mumbai

©ICAR-Central Institute for Research on Cotton Technology 2020

ICAR-CIRCOT Annual Report 2019 is an in-house publication. Readers are not permitted to use or sell the data, photographs and figures presented in the report. This is a publication about research work and other activities carried out in the Institute during the year 2019

Citation: ICAR-CIRCOT Annual Report 2019. ICAR-Central Institute for Research on Cotton Technology, Mumbai

CONTENTS

Abbreviations

Preface

Executive Summary

1	Introduction	01
2	Salient Research Achievements	06
3	Technology Management	42
4	Skill Development and Capacity Building	48
5	Linkages and Collaboration	56
6	Awards and Recognition	61
7	Publications	66
8	IMC, RAC and IRC meetings	72
9	Participation in Seminars / Conferences / Meetings/ Workshops	75
10	Events Organised	82
11	Hindi Implementation	92
12	Distinguished Visitors	95
13	Swachh Bharat Abhiyan	98
14	Mera Gaon Mera Gaurav	106
15	Infrastructural Facilities	109

Annexures

I.	List of On-Going Projects	112
II.	Personnel	116
III.	List of Committees	123
IV.	Citizen Charter	129
V.	Right to Information	130

ABBREVIATIONS

ABI	Agri-Business Incubation
AFIS	Advanced Fibre Information System
AFM	Atomic Force Microscopy
AICRP	All India Coordinated Research Project
AKMU	Agricultural Knowledge Management Unit
ASRB	Agricultural Scientists Recruitment Board
ASTM	American Society for Testing and Materials International
BIS	Bureau of Indian Standards
BSKKV	Dr. Balasaheb Sawant Konkan Krishi Vidyapeeth
CBPD	Chemical & Biochemical Processing Division
CIRCOT	Central Institute for Research on Cotton Technology
CTRL	Cotton Technological Research Laboratory
DR Gin	Double Roller Gin
FTIR	Fourier Transform Infrared Spectroscopy
GTC	Ginning Training Centre
HDPS	High Density Planting System
HVI	High Volume Instrument
ICAR	Indian Council of Agricultural Research
ICCC	Indian Central Cotton Committee
ICT	Institute of Chemical Technology
IFS	Indian Fibre Society
IJSC	Institute Joint Staff Council
IMC	Institute Management Committee
IP	Indian Pharmacopoeia
IRC	Institute Research Council
ISAE	Indian Society of Agricultural Engineers
ISCI	Indian Society for Cotton Improvement
ISO	International Organization for Standardization
ITMF	International Textile Manufacturers Federation
ITMU	Institute Technology Management Unit
MFC	Micro Fibrillated Cellulose
MGMG	Mera Gaon Mera Gaurav
MoU	Memorandum of Understanding
MPD	Mechanical Processing Division
NABL	National Accreditation Board for Testing and Calibration of Laboratories
NAIF	National Agriculture Innovation Fund
PMC	Project Monitoring and Evaluation Committee
QEID	Quality Evaluation and Improvement Division
QRT	Quinquennial Review Team
R&D	Research and Development
RAC	Research Advisory Committee
RAFTAAR	Remunerative Approaches for Agriculture and Allied Sector Rejuvenation
RKVY	Rashtriya Krishi Vikas Yojana
RPM	Revolutions per minute
SEM	Scanning Electron Microscopy
SBEE	Society of Benin Electrical Engineering
SNDT	Shreemati Nathibai Damodar Thackersey (Women's University)
TAP	Technical Assistance Programme
TTD	Technology Transfer Division
USDA	United States Department of Agriculture
VJTI	Veermata Jijabai Technological Institute

PREFACE



Cotton, the most important cash crop, plays a dominant role in the Indian economy through its contribution in the Country's GDP, industrial output, employment generation and export earnings. Around 6 million farmers are involved in cotton cultivation, covering an area of about 12.7 million ha with an estimated output of 354.5 lakh bales of cotton lint during 2019-20. ICAR-Central Institute for Research on Cotton Technology, dedicated to the R&D of post-harvest aspects of cotton and its agro residues, is serving the stakeholders of cotton sector for over 95 years.

During the year 2019, the Institute has continued to support the release of quality cotton varieties for the benefit of farming community. It also provided support and training to the farmers and workers for clean cotton picking to reduce the trash content. Institute has developed trash handling system and cottonseed quarantine system to eradicate the pink bollworm in the ginneries. As a part of the Institutes outreach programme, a Pilot Project was launched for trading of the seed cotton on the basis of lint realization or Ginning Percentage (GP) in association with Agricultural Produce Market Committee (APMC), Hinganghat, Maharashtra, a major Cotton Mandi of Central India.

This Institute revived the interest in promotion of naturally coloured cotton production and its value addition. ICAR-CIRCOT has signed a Tri-Partite MoU with Dr. Panjabrao Deshmukh Krishi Vidyapeeth, Akola and ICAR-Central Institute for Cotton Research, Nagpur for growing of naturally coloured cotton and is supporting the budding entrepreneurs for developing novel textile products through its incubation centre. This year saw a quantum leap in the field of nanotechnology research with the commercialization of Nano-ZnO production technology to M/s. Rashtriya Chemicals and Fertilizers (RCF) Ltd, Mumbai for its application in fertilizers.

The institute, working towards achieving sustainability in textile processing, has developed eco-friendly bleaching technology for production of absorbent cotton and salt free dyeing technology for cotton textiles. ICAR-CIRCOT's salt-free dyeing technology was demonstrated to the stakeholders at Tiruppur, which is one of the largest textile processing clusters in southern India.



The institute is putting yeoman service for the value addition of cotton agro residues. The ICAR-CIRCOT's Green Crematorium, which uses briquettes from cotton stalk, was commercialized and is operational in Ambazari Ghat, Nagpur Municipal Corporation. Also, a new stove, which can use pellets prepared using cotton stalks, was developed and commercialized. Cotton biomass based composite trays are being evaluated for growing of nursery seedlings as an alternative to that of existing plastic trays, in collaboration with ICAR-Directorate of Floricultural Research, Pune. The institute is putting considerable efforts in generation of wealth from the waste to augment the farmers Income.

ICAR-CIRCOT's leadership position in imparting high-end training programmes to various stakeholders is continuing with organizing of 22 programmes during 2019. As a referral laboratory for cotton textiles, ICAR-CIRCOT has been serving the needs of the stakeholders through consultancy and commercial testing services. Institute has earned Rs 1.91 crores during 2019 which is approximately 30% of the allocated plan budget.

The RKVY-RAFTAAR-Agri-Business Incubation Centre in the Institute has launched two programmes, UDAY and ANKUR, to attract innovative business ideas in the field of Agriculture and nurture them into viable start-ups with Grant-in-Aid capital. This Institute continued to be the forerunner in implementation of Government initiatives like Mera Gaon Mera Gaurav, Renewable source of energy, Waste to wealth and Make in India.

This 'Annual Report 2019' deviates from the previous reports (2018-19, 2017-18 ...), as it shifts the time line from financial year to the calendar year. I acknowledge the contributions from all staff members of the Institute in driving the legacy of the Institute with enthusiasm towards achieving global excellence in cotton textiles.

Mumbai
25-01-2020

Dr. P.G. Patil
Director

EXECUTIVE SUMMARY

ICAR-CIRCOT's dedicated scientific and technical workforce is always striving hard towards achieving sustainability & inclusive growth in the cotton sector. The Institute undertakes research activities in 5 major core areas viz.

- i. Pre-ginning and Ginning;
- ii. Mechanical processing: Technical textiles and Composites;
- iii. Characterization - Cotton and other natural fibres, yarns and textiles;
- iv. Chemical and Biochemical processing of cotton and its biomass & by-product utilization;
- v. Business incubation, Entrepreneurship and Human Resource Development.

The salient achievements made by the institute during 2019 are :

Research

Three process technologies and nine machineries / value added products have been developed during 2019.

Process technologies

- Electrodialysis process for decolouration of dyeing effluents
- Bio-based hydrophobic treatment for lignocellulosic molded plates
- Process protocol to destroy pink bollworms from gin trash in cotton ginneries

Machineries / Value added products

- Trash handling system for control of pink bollworm in cotton ginneries
- Banana fibre based Kraft pulping for packaging
- Conductive yarn for smart textiles
- Development of cotton based smart heating Gloves
- Pellet stove for cotton stalk (biomass) pellets
- Cotton gauze with improved absorbency property for wound dressing

- Activated carbon based protective mask
- Banana filament fibre spinning machine
- Natural fibre based herbal fragrance release product for well-being

Publications

- Published 23 research papers in peer reviewed journals; 16 conference papers presented; 4 training manuals, 5 Book chapters, 2 popular articles, 1 Booklet "ICAR-CIRCOT Value Addition Technologies on Cotton By-Products for Eastern and Southern Africa"; 4 Brochures, 19 leaflets; and 17 flyers were published.

Skill Development initiative

- 22 training programmes including one international training, 11 specialized (self-sponsored) trainings & 10 Farmers trainings have been organized, benefitting 426 participants. Revenue generated from training during 2019 was ₹23.46 lakhs.

Technology Management & Popularisation

- Eight consultancies were undertaken and ten MoUs were signed for Research collaboration, technology commercialization and incubation.
- In Collaboration with UNCTAD, ICAR-CIRCOT conducted a workshop under the United Nations Development Account Project 1617K on "Promoting Cotton by-products in Eastern and Southern Africa" for participants from Zambia, Zimbabwe, Tanzania and Uganda. Significant contribution made by the institute in the project has been duly acknowledged by the Letter of appreciation from UNCTAD.
- Organized / participated in 3 exhibitions, 2 industry-interface meets as well as participated in various meetings, seminars, workshops and conferences for popularizing institute technologies among stakeholders.
- Mera Gaon Mera Gaurav (MGMG) activities were conducted in 30 cotton growing villages in Wardha district of Maharashtra where scientists and technical officers

demonstrated farmer friendly technologies for enhancing farm income. In 2019, ICAR-CIRCOT conducted 12 village visits, interface meetings, demonstrations and awareness programs in which about 1451 farmers from the adopted villages participated

- In order to promote lint-based marketing of cotton, ICAR-CIRCOT in association with APMC, Hinganghat and Agro-plus Foundation, Nagpur launched the first of its kind “Centre for Determination of Ginning Percentage (GP)” on December 31, 2019 in the premises of APMC market yard at Hinganghat.
- Two television talks on DD Sahyadri and one radio talk on All India Radio were delivered by Institute Scientists.

Accreditation, Awards and Recognition

- Accredited with ISO 9001:2015 for Quality Management System by Bureau of Indian Standards.
- NABL accreditation for Mechanical and Chemical testing of cotton fibre yarn and fabrics under ISO/ IEC 17025:2005.
- Received Doordarshan Sahyadri Krushi Sanmaan Award 2019 in the category of Research in Agriculture / Meritorious work in Innovative Field
- Dr. N. Vigneshwaran, Principal Scientist received International Cotton Researchers Association (ICRA) – ASIA Young Scientist Innovation Medal – 2019.
- Ashirvad Rajbhasha Gaurav Puraskar for outstanding Hindi implementation activities in the institute for the year 2019 was awarded to Dr. P. G. Patil, Director

Commercial Services

- ICAR-CIRCOT continued as Approved Assayer with Indian Clearing Corporation Ltd. and Multi Commodity Exchange of India Ltd.
- During 2019, a total of 19,218 samples were tested at Mumbai headquarters, GTC Nagpur and other regional units generating a total revenue of ₹97,47,827/- through commercial testing.

- ICAR-CIRCOT calibration cotton, is an import substitute for USDA standards for calibrating textile testing equipment. 289 containers of calibration cotton was sold to stakeholders generating revenue of ₹2,73,105/- during the year 2019.
- ABI centre at ICAR-CIRCOT: Two incubatees graduated and three new incubatees are admitted during 2019 for developing new enterprises in 'Development of starch based film for packaging', 'Mechanical Property Testing of Paddy straw particle boards' and 'Preparation of bio-degradable products using agro biomass (banana fibre, rice straw, bagasse)'.
• ICAR-CIRCOT has been bestowed with RAFTAAR - Agri Business Incubation Centre (R-ABI) of RKVY by the Department of Agricultural Cooperation and Farmers welfare. Five applicants for pre-seed stage funding and ten applicants for Seed stage funding are selected.

Financial Management

- All transactions in the Institute are 100% digital and cashless.
- The Institute ensured complete utilization (100%) of the sanctioned budget allocation during 2018-19 and 86.28% during 2019-20 (up to 31 December 2019).
- The revenue generation is ₹191.57 lakhs during the year 2019.

Extracurricular activities

- Institute has participated in the ICAR inter zonal sports tournament and got one gold, three silver and one bronze medals. The Institute bagged four gold and eight silver medals in various events in the ICAR west zone sports tournament.
- Cleanliness programmes under *Swachh Bharat Abhiyaan* in the Institute premises and at the staff quarters were regularly conducted throughout the year with active participation of the staff.

1. Introduction

ICAR-CIRCOT is a premier research institute working in the field of post-harvest processing of cotton and value addition to its biomass under the Indian Council of Agricultural Research (ICAR). This institute was established in 1924, as the Technological Laboratory under the Indian Central Cotton Committee (ICCC). The administrative control of the Institute was transferred to ICAR in 1966 and the institute was renamed as Cotton Technological Research Laboratory (CTRL). In the year 1991, the institute was renamed as Central Institute for Research on Cotton Technology (CIRCOT). The institute has made significant contributions to the stakeholders of the Cotton and allied sectors for over 95 years.

ICAR-CIRCOT is under Agricultural Engineering Subject Matter Division (SMD) of ICAR and has headquarter at Mumbai. The Vision of the institute is “*Global Excellence in Cotton Technology*” and the institute is functioning with the following mandates :

1. Basic and Strategic Research on Processing Cotton and its Agro-Residues, Development of Value Added Products and Quality Assessment
2. Skill Development and Business Incubation Services and Function as Referral Laboratory for Cotton Fibres

The institute has four research divisions namely, Quality Evaluation and Improvement Division (QEID), Mechanical Processing Division (MPD), Chemical & Biochemical Processing Division (CBPD) and Technology Transfer Division (TTD) to facilitate and monitor the Research, Consultancy, Training, Testing, Technology Transfer, Incubation and supporting the start-ups. The institute has six regional units namely Ginning Training Centre at Nagpur and Regional Quality Evaluation Units situated at Coimbatore, Sirsa, Surat, Guntur and Dharwad.

The Director is heading the Institute with the assistance from the heads of four research divisions, administration and finance & accounts sections. The Priority-setting, Monitoring and Evaluation (PME) Cell assists the Director in assessing the performance of various research projects, handling communications with the council etc.

The Research Advisory Committee (RAC) guides the Director in streamlining the research programmes of the institute. The research programmes are carried out under the following five broad core areas :

- i. Pre-ginning and ginning
- ii. Mechanical processing: Technical textiles and Composites
- iii. Characterization: Cotton and other natural fibres, yarns and textiles
- iv. Chemical and biochemical processing and Biomass & by-product utilization
- v. Entrepreneurship and Human Resource Development

The contribution of the Institute to the progress of post-harvest processing of cotton and value addition to cotton by-produce over the past nine and half decades of its existence is phenomenal. The institute is one of its kind in the World to carry out research solely on Cotton. The institute has also played a pivotal role under the Technology Mission on Cotton (TMC) in Modernization of the Ginning Industry in the country. The significant contributions in the area of ginning machinery research have helped the country to be self-reliant and also become net exporter of ginning machinery. The Ginning machinery are now being exported to the Afro-Asian countries earning precious foreign exchange for the country.

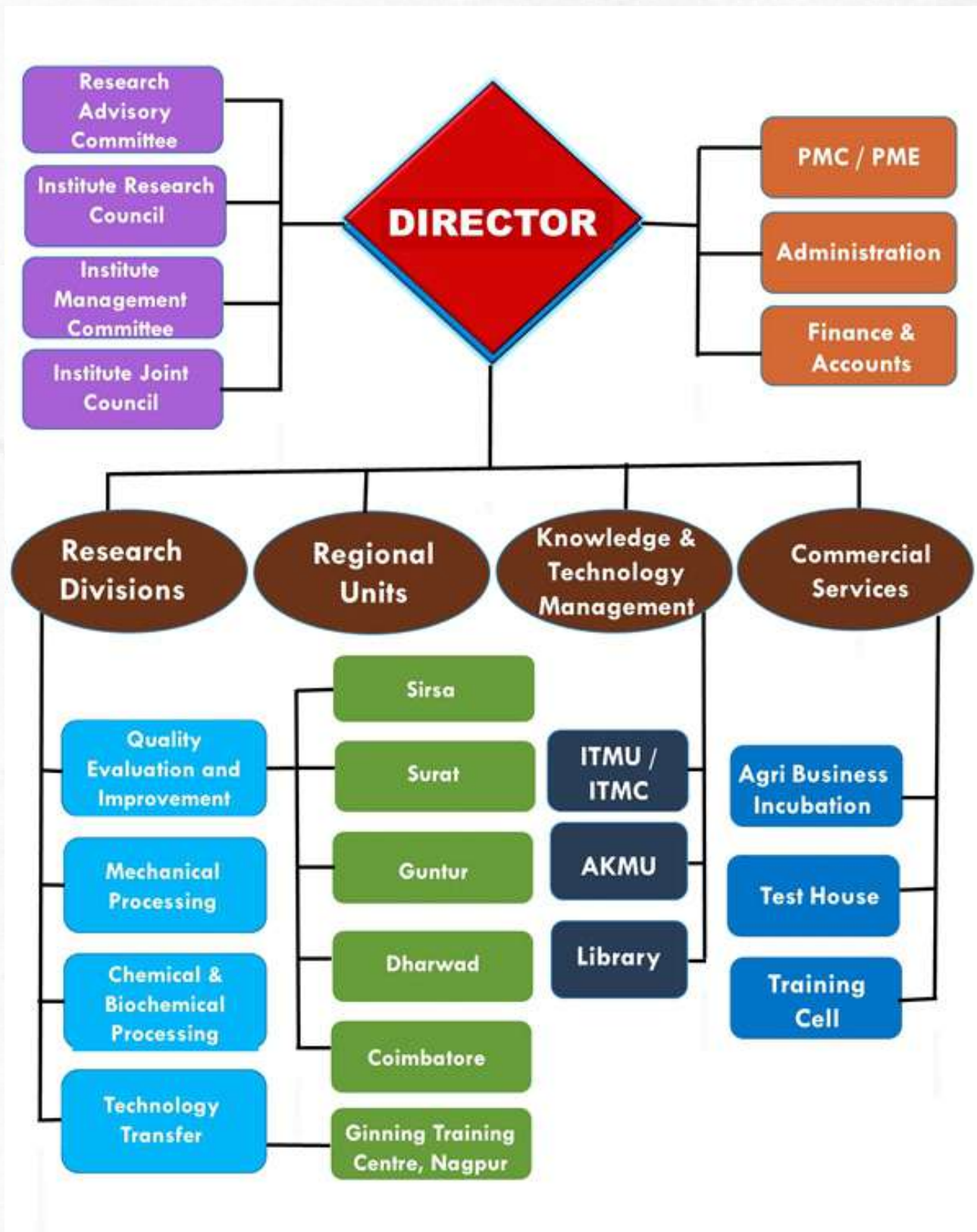

Organogram of ICAR-CIRCOT, Mumbai

The Institute has an important role as the Technology partner under the All India Coordinated Research Project (AICRP) on Cotton for developing and screening quality cotton genotypes. Lauding its efforts, the status of the Institute has been designated as Principal Investigator for Quality Research in the project. ICAR-CIRCOT calibration cotton, an indigenously developed Standard Reference Material, is an import substitute for the USDA reference material used for calibrating fibre testing instruments such as High Volume Instrument (HVI).

The institute is also supporting the private sector in its R&D efforts for development of machineries in the post-harvest processing of cotton and value addition to agro-biomasses. The institute has successfully commercialised new machines and products developed in the institute, some of them worth mentioning are on-board pre-cleaner for cotton stripper, saw band pre-cleaner for mechanically picked cotton, stick remover for mechanically picked cotton, double roller gin with self-grooving rubber roller, miniature spinning system and village level sliver making machine, cotton lint opener, rubber composites for flexi check dam etc. Many process technologies for the value addition of cotton fibres and cotton biomass are also developed and demonstrated by the Institute. The Green Crematorium using cotton stalk briquettes and continuously feeding pellets stove developed by the institute are commercialised.

Recently, the Institute has been carrying out research in diverse areas and developed products and processes like cotton rich blended fabrics for sportswear, application of cotton in technical textiles especially medical textiles, mosquito repellent finishing for textile materials, solvent extraction process for gossypol removal in cottonseed meal for use as non-ruminant feed, salt free dyeing technology, value added products from Banana fibres and Naturally coloured cotton based products.

The institute has done a pioneering work in the area of nanotechnology and its application in textiles & composites. A Nanocellulose Pilot Plant facility, first of its kind in the World to produce nanocellulose from cotton, was established in the year 2015, based on the indigenous chemo-mechanical process. The processes to impart various functional finishes to cotton textiles such as anti-microbial, UV protective, water repellence using nanomaterials have been developed by the Institute. Applications of nanocellulose in cement concrete, rubber composite, pulp and paper to enhance functional properties and in paint formulation as a rheology modifier have also been carried out. The development of security grade paper from a blend of natural fibre pulp and imparting security feature have also been demonstrated by the Institute. In this year, nano-ZnO production technology for fertilizer application was commercialized to M/s. Rashtriya Chemicals and Fertilizers, Mumbai.

ICAR-CIRCOT is the Lead institute and the Nodal Centre for implementing the Consortia Research Platform (CRP) on Natural Fibres. The project is implemented in collaboration with ICAR-NINFET, Kolkata, Assam Agricultural University (AAU), Jorhat, Tamil Nadu Agricultural University (TNAU), Coimbatore.

The Institute has been offering innovative tailor made skill development programmes at national and international level in a host of subjects that were not offered before. The institute also offers farmers training programme on post-harvest processing and value addition to cotton by-produce, Increase in farm income through increase in production and processing at Village level. The institute also caters to the capacity building needs of the cotton sector in the African countries. Under the Cotton Technical Assistance Programme (Cotton TAP) for Africa, the institute has contributed towards capacity building of the

stakeholders in seven African countries viz., Benin, Burkina Faso, Chad, Mali, Malawi, Nigeria and Uganda. ICAR-CIRCOT was also instrumental in establishing a Regional Knowledge Cluster cum Training Centre for Post-harvest and Ginning Technologies at Bohicon, Benin. The institute also caters to skill building of the African Stakeholders under the Short Term Training Programme as per Indo-African Forum Summit. Recently ICAR-CIRCOT is assisting the United Nations Conference on Trade and Development (UNCTAD) in implementing a UN Development account Project 1617K on “Promoting Cotton by-products in Eastern and Southern Africa” in Zambia, Zimbabwe, Tanzania and Uganda.

The Agri-Business Incubation (ABI) Centre of the institute is promoting and nurturing the new enterprise based on the technologies of post-harvest processing and value addition to cotton and other natural fibre biomass In line with the Government programme of Start-Up India.

Coherent with the government initiative for doubling farmers' income, the Institute has taken up many innovative projects. Value addition to cotton biomass through preparation of compost from cotton biomass, popularisation of mushroom cultivation using cotton biomass and preparation of briquettes and pellets from cotton stalks as a source of renewable energy are some of the activities taken up for creating economic value for the cotton stalks and enhancing the farm income.

The track record of ICAR-CIRCOT is very good in meeting the revenue generation target provided by the Council through its Internal Resource Generation. The institute generated revenue through Technology Commercialization, Technology Incubation Service, Consultancy and Commercial testing services besides sale of the products developed based on Institute technologies. ICAR-CIRCOT

makes every effort to ensure 100 % utilization of the allocated Funds.

The Institute is one of the most recognised laboratories for testing of cotton fibres, yarn and textiles made of cotton and cotton blends with other fibres. It provides commercial services for the stakeholders in the cotton value chain. Some of the testing facilities in the institute is accredited with ISO 17025:2005 by the National Accreditation Board for Testing and Calibration of Laboratories (NABL) since 1999. The Institutes is also accredited with ISO 9001:2015 for Quality Management System by the Bureau of Indian Standards (BIS).

The staff position of the institute as on 31-12-2019 is given in Table 1.1. The institute is running with 50% of strength in Scientific and Technical category.

Table 1.1 Staff Position as on 31.12.2019

Category	Sanctioned	In-Position	Vacant
Scientific	50	29	21
Technical	112	64	48
Administrative	47	30+2	17
Supporting	57	36	21
Total	266	159+2	107

Table 1.2 shows the status of fund utilization during the year 2019 for the Institute and for CRP on natural fibres.

Table 1.2 Funds Utilisation during the Year 2019

₹ Lakhs

Head of Expenditure		ICAR-CIRCOT (including SCSP)		CRP on Natural Fibres	
		Allocation (2019-20)	Expenditure (Apr – Dec 2019)	Allocation (2019-20)	Expenditure (Apr – Dec 2019)
Grant-in-Aid- Capital		151.96	123.36	5.49	2.25
Grant-in-Aid- Salaries		2068.50	1536.78	--	--
Grant-in- Aid- General	Pension only	261.00	103.24	--	--
	Other than Pension	586.06	389.08	67.26	48.42
Total		3067.52	2152.46	72.75	50.67

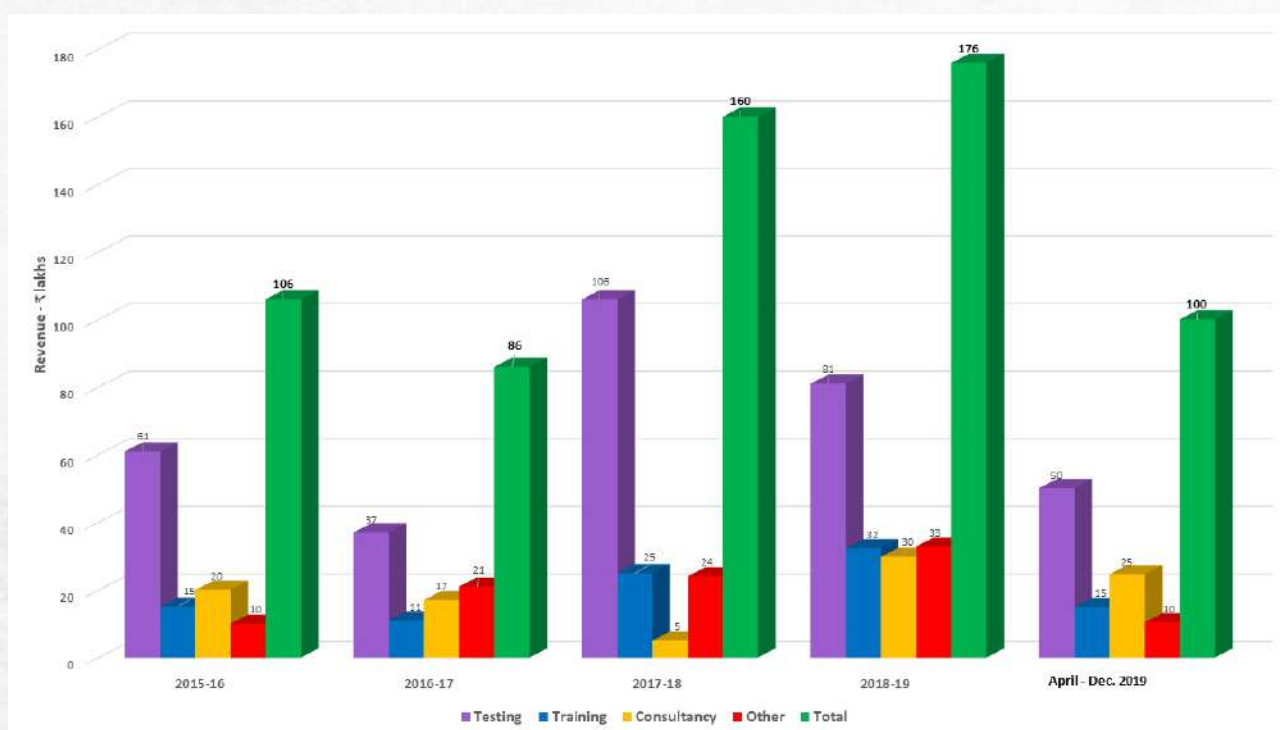

Revenue Generation (₹ Lakhs)

2. Salient Research Achievements

2.1 CORE AREA - I: PRE-GINNING AND GINNING

2.1.1 Efficient System for Processing of Kawadi Cotton in Ginneries

Seed-cotton arriving into ginning factory may contain impurities in the form of leaves and bracts that are removed in the cleaning systems in ginneries like pre-cleaner and hot-box dispenser. Some immature and infested seed-cotton is also dispensed during pre-cleaning as it is not ginnable due to its unopened fibres which are closely attached to the seed. Such unopened seed-cotton is called as 'Kawadi Cotton' due to its typical shape that resembles *kawadi* sea shells.

The *kawadi* cotton separated in different cleaning sections is generally ignored by ginners considering it as a waste material, however, it can be processed and good quality lint can be recovered from it. The Indian Ginning Industry is asking for an efficient solution to process this material. Already some machines are available in the market for cleaning and opening of *kawadi* cotton, one of which "Bajaj Boll Opener" was taken up for testing, evaluation and modification for development of a new efficient machine.

The test trial of 'Bajaj Boll Opener' was conducted in the factory premises of the Bajaj Steel Industries Ltd (BSIL), Nagpur for development of a new system with improved

efficiency. The capacity of this machine for processing of raw *kawadi* cotton was 850 kg/h. The bulk density of raw *kawadi* cotton (134 kg/m^3) gets reduced to almost half (73 kg/m^3) on passing through the opener, indicating fibre is ginnable. About 40% *seed* cotton could be recovered for ginning, the rest going out as losses through different mesh screens, dust and feeder splash-out. The opened *kawadi* cotton was ginned using both double roller (DR) and saw gin with the lint recovery of 22-25%.

During the test trial, it was found that some modifications in the machine design can be made to reduce the fibre losses for increasing the recovery of useful seed-cotton and lint. For example, Feed Hopper Modification can help to arrest splash-out losses during feeding. Some *kawadi* cotton that gets stuck in between the peripheral support flat of the fan and the screen underneath near the feed section may lead to fire hazard due to friction and must be corrected. There is also a risk of operator hand injury at the outlet chute, which must be avoided for enhanced operator safety.

Keeping in view the above shortcomings, a new machine design has been prepared for fabrication.

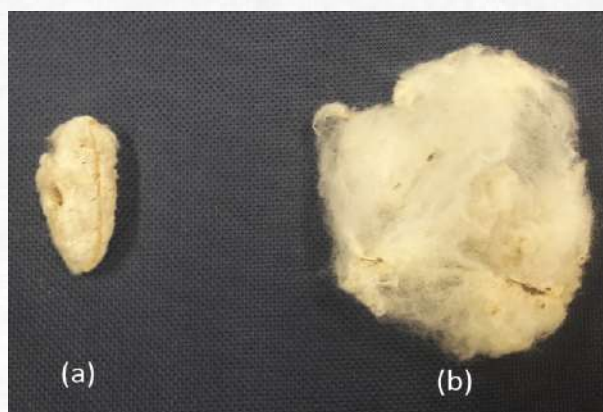

(a) Raw Kawadi Cotton (b) Opened Kawadi Cotton



Bajaj Boll Opener

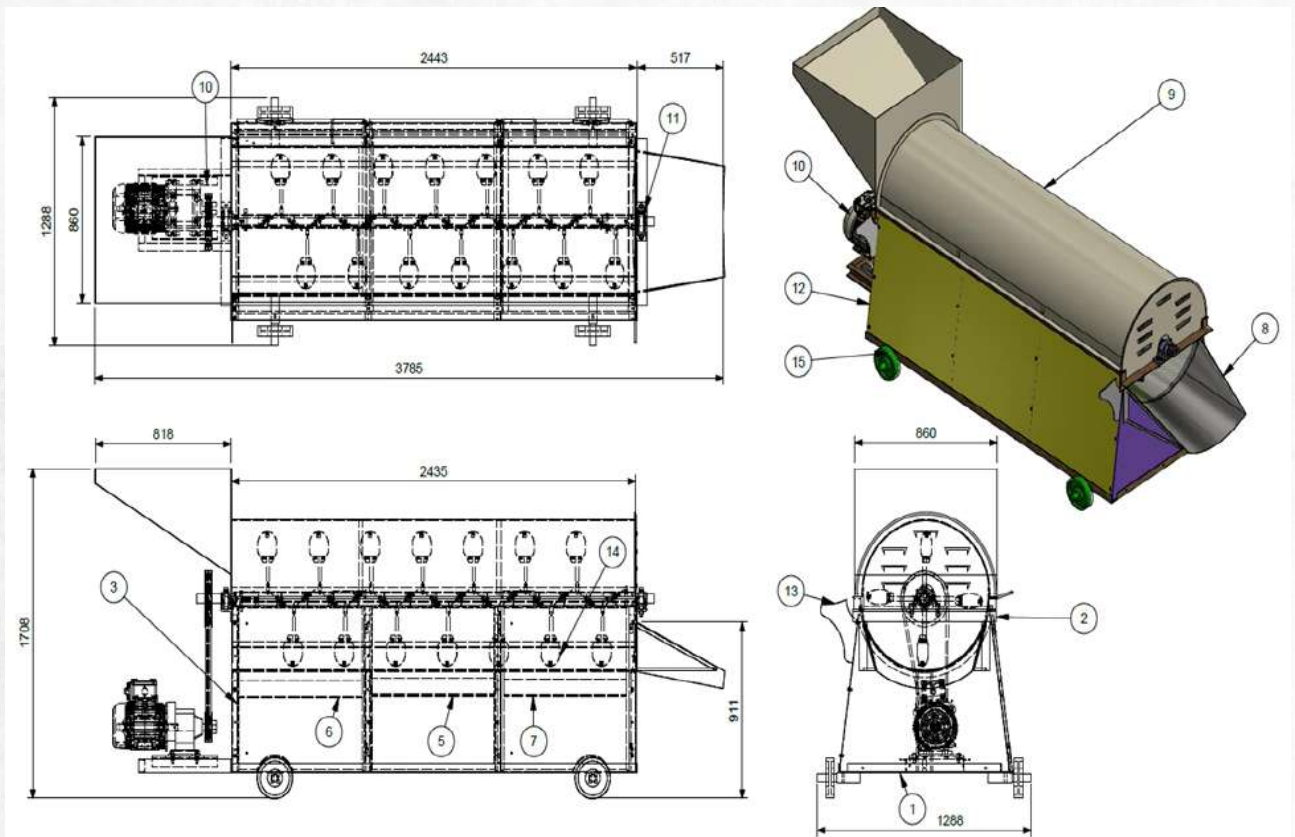

Kawadi Opener AutoCAD drawings showing different views of the new system

2.1.2 Process protocol to eradicate pink bollworms from gin trash in cotton ginneries

Pink bollworm is a dreaded pest that causes significant yield loss and affect cotton fibre quality and thus adversely affects income of cotton farmers and ginners. Cotton ginneries serve as site for reintroduction of pink bollworm (PBW), because during ginning process, live PBW are likely to escape through the gin trash and get disseminated in neighbourhood areas causing PBW incidence in cotton fields. Hence to break down the life cycle of PBW and prevent damage to cotton crop in subsequent season, a gin trash handling system has been developed in such a way that all PBW are destroyed.

The trash handling system with capacity to handle 2.5 tons trash per hour comprise of trash fan, ducting, cyclone and compactor. The trash fan wheel which crushes gin trash should have minimum of six number of straight blades with minimum fan diameter of 490 mm. The trash fan should generate an air volume of 4800 m³/h and run at a pressure of 363 mm wgp. The minimum fan tip speed of 4192 m/min i.e. about 3000 rpm should be maintained. The minimum air velocity through 254 mm ducting should be more than 17 m/s. The 1D-3D cyclone with diameter of 815 mm and height of 2445

mm needs to be employed to separate out air and trash passing through the trash fan with a pressure drop of 360 mm wgp. The compactor enables the volume reduction and cost effective disposal of gin trash after treatment. The screw conveyor with pitch and diameter of 320 mm should run at a speed of 72 rpm.

Performance of trash handling system in terms of mortality rate of PBW was assessed by using trashes viz. cyclone fly waste (T1), lint cleaner waste (T2) and pre-cleaner waste (T3). Experiments were conducted by preparing samples with different configurations of gin trash and PBW culture i.e. larva and pupae. Developed system successfully attained the intended function of destroying PBW and the mortality rate of larva and pupae was found to be 100% (Table 1). Ginning performance of pink bollworm infected cotton on DR gin showed 17%, 14% and 11% reduction in ginning percentage, fibre length and tenacity respectively along with significant deterioration in colour grade of cotton. Gin trash handling system is recommended to eradicate and prevent dissemination of pink bollworm from cotton ginneries.

Table 1: Kill potential of pink bollworm (Larvae and Pupae) after passing through gin trash handling system

Replication	Cyclone fly waste (T1)				Lint cleaner waste (T2)				Pre-cleaner waste (T3)			
	One day after treatment (L/N)		Thirteen days after treatment (L/N)		One day after treatment (L/N)		Thirteen days after treatment (L/N)		One day after treatment (L/N)		Thirteen days after treatment (L/N)	
	Larvae	Pupae	Larvae	Pupae	Larvae	Pupae	Larvae	Pupae	Larvae	Pupae	Larvae	Pupae
R1	0/15	0/15	0/15	0/15	0/15	0/15	0/15	0/15	0/15	0/15	0/15	0/15
R2	0/15	0/15	0/15	0/15	0/15	0/15	0/15	0/15	0/15	0/15	0/15	0/15
R2	0/15	0/15	0/15	0/15	0/15	0/15	0/15	0/15	0/15	0/15	0/15	0/15
Control	0/0	0/0	0/0	0/0	0/0	0/0	0/0	0/0	0/0	0/0	0/0	0/0

L=Live PBW, N= Total PBW



(a) Feeding of gin trash with PBW culture through inlet



(b) Trash fan



(c) Collection of samples at the outlet

Trash handling system to control pink bollworm from gin trash in cotton ginneries

2.1.3 Development of a Rotary Tubular Drum Dryer for Quarantine of Pink Bollworm infested Cottonseeds in Ginneries

A Rotary Tubular Drum Dryer (RTDD) has been designed and modelled using 3D CAD software on the lines of dryers used in Egyptian and US ginneries for quarantine of cottonseed against pink bollworm before being shipped outside ginning factories. The RTDD was designed for indirect heating of 1 tonne/h ginned cottonseed to about 65°C for 5-6 min. Thermic fluid HYTHERM 500 was considered as heating medium for drying of cottonseed. The thermic fluid temperature of 180 °C was considered as heating temperature for drying of cottonseed. The designed RTDD consists of a bucket elevator, rotary joint, a bunch of 20 circular pipes fitted over periphery of a main annular central pipe, moisture transportation system and seed conveying and bagging system. The bucket elevator has been designed for cottonseed loading capacity of 2 tonnes/h. The length, width and height of the designed bucket elevator were 210, 510 and 2800 mm,

respectively. The rotary joint having 75 mm and 90 mm diameter has been designed for supply of hot and cold fluids into and out of the dryer. The hot thermic fluid at about 180 °C enters the central hole of the main annular pipe having 127 mm diameter internal diameter and 7.6 mm thickness through the rotary joint. The central main annular pipe distributes the hot fluid to a bunch of 20 pipes having 50.8 mm internal diameter and 5 mm thickness through the 4 manifold pipes. The hot fluid circulated in these pipes supplies heat to cottonseeds and leaves the dryer through rotary joint via annular space of the main central pipe. A moisture transportation system was designed for removal of moisture evaporated during heating from the dryer. It consists of a centrifugal fan and a 2D2D cyclone having 600 mm barrel diameter. An air damper has been provided at the fan inlet to control the air flow rate of the moisture transportation system.

A belt conveyor system has been designed for transportation and bagging of the dried seed. The main annular central pipe is designed to be rested on two heat resistant bearings on either side. The power requirements for operation of entire components has also been determined. Cottonseed fed through the bucket elevator is to be lifted and pushed inside the drum of the dryer through the flights and shovels, respectively. The number and shape of the flights influence the amount of material present

in the rotary dryer. Flights are designed considering that the volume occupied by the load of solids in the rotary dryer shall be between 10 and 15% of the total dryer volume. The designed flights are to be distributed across the drum, such that the volume of cottonseed transported by the flights is also between 10 and 15% of the total material volume within the dryer. The flights of the rotary drum dryer used in the present work are of the two-segment type as shown in the figure.

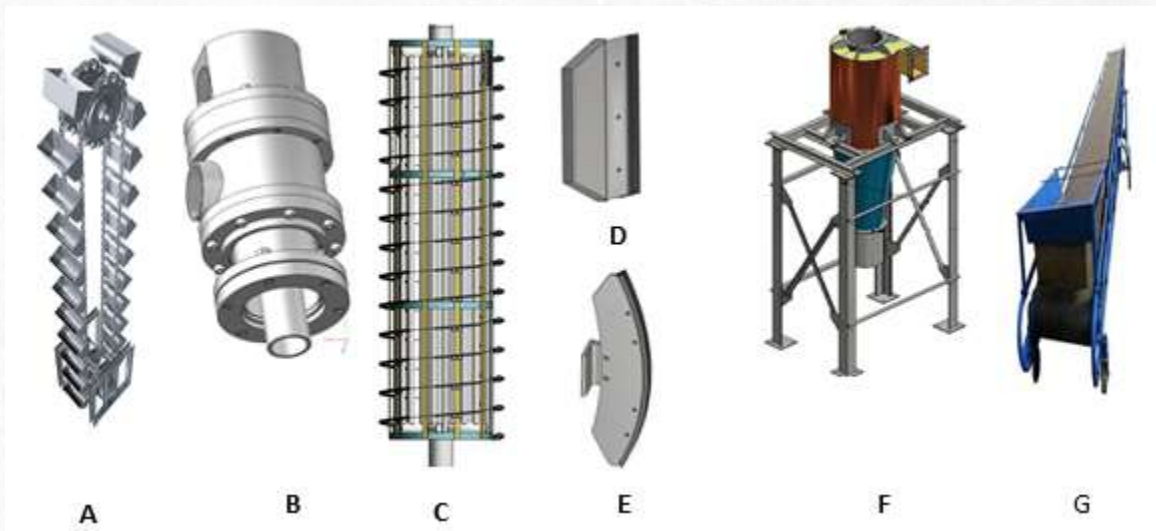

A : Bucket elevator, **B** : Rotary joint, **C** : Assembly of tubing system, **D** : Flights, **E** : Lifters, **F** : Cyclone assembly and **G** : Cottonseed transportation and bagging assembly.



Figure: Different components of the designed and modelled Rotary Tubular Drum Dryer (top) and the Rotary Tubular Drum Dryer

2.2 CORE AREA - II: MECHANICAL PROCESSING, TECHNICAL TEXTILES AND COMPOSITES

2.2.1 Development of activated carbon based protective mask

Air filters (Mask) used to protect against contaminants from air (including moulds, gases dirt and odour) are designed as per specified needs and all filters doesn't serve the same purpose. Filters are made from various fibres and yarns. Their constructions and compositions are based on the types of pollutants: gases, particulate matter, metals and salts that are present in the atmosphere. To filter the above pollutants, filter medium should incorporate adsorbent/catalyst as one of the layer. The most common adsorbent used is activated carbon which is predominantly an amorphous solid with large internal surface area and pore volume. Activated carbons (AC) are known as very effective adsorbents due to their highly developed porosity, variable characteristics of surface chemistry, and high degree of surface reactivity. The surface reactivity of the activated carbon is influenced by the production methods. The activated carbon was produced from cotton stalks using chemical activation method. It was coated in the cotton based woven fabric of various GSM using adhesives & binders to assess its efficiency in filtration

The surface morphology and distribution of the activated carbon coated fabric was studied using scanning electron microscope.

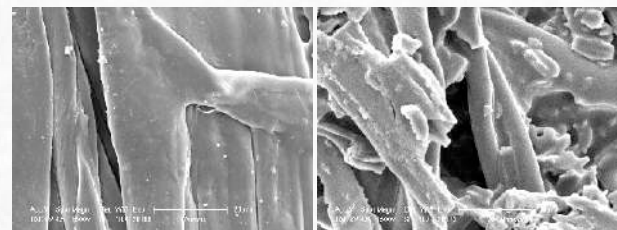

Control Fabrics

AC Coated Fabrics

The porosity of control fabrics and activated carbon coated fabrics were analysed. The Mesoporosity was analysed by methylene blue adsorption test, Microporosity was analysed by iodine adsorption test and surface area was analysed by BET surface area analyser. The results of control and treated samples along with AC are given in the figure which shows that control cotton fabrics surface area is 296m²/g whereas activated carbon coated fabric was 842 m²/g, almost three times increase in surface area after coating of the fabrics.

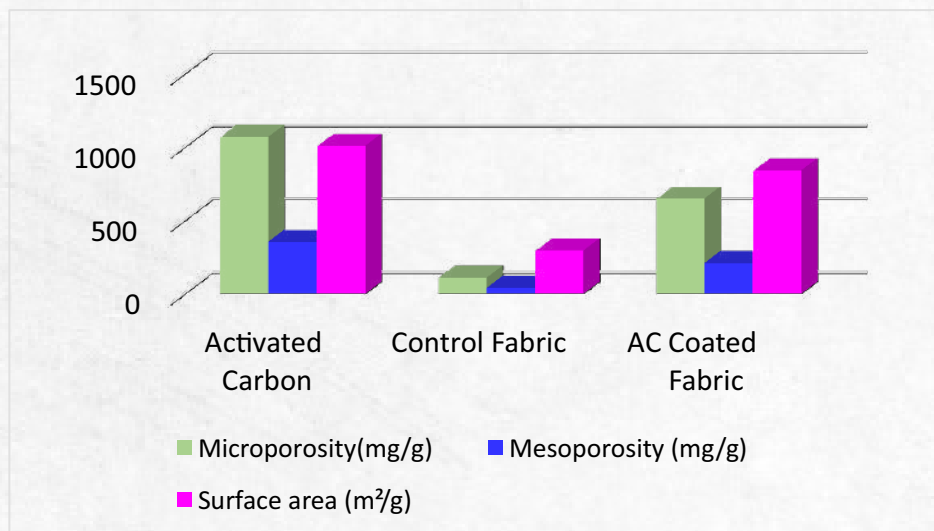

Figure : Porosity and surface area of activated carbon, control and coated fabric

2.2.2 Development of High Performance Cotton Pads for Wound Dressing

The wound is a disruption of the continuity of the tissues by external mechanical force resulting from a blow, cut or other impact. The main function of wound dressing is to promote healing and protect the wound from further infection. Presently synthetic fibre based wound dressing materials are predominantly used. Using of cotton fibre and its hybrid based nonwoven materials with antimicrobial properties, as dressing material will (a) keep the wound moist with exudates without being macerated (b) free from infection (c) improve the duration of wound dressing and (d) cost-effective.

With this aim a cotton gauze fabric was developed with improved absorbency & wicking properties along with antimicrobial finishing through an in-situ technique using nano-silver. The treated cotton gauze fabric shows 100% antimicrobial efficacy against both *K. pneumoniae* and *S. aureus*. The developed fabric was kept as surface layer of cotton based non woven pad produced by Needle punching technique. The developed composite had showed good antimicrobial and improved absorbency properties. The performance of the wound dressing pad is under clinical trial at KEM Hospital, Sion Hospital and Tata Memorial hospital.



Biodegradable Composite Wound Dressing Pad with Antimicrobial Properties



Composite Wound Dressing Pad With Improved Absorbency Properties.

2.2.3 Development of Cotton Based Smart Fabric for Warm Pads and Garments

Cotton based heating glove was developed using conductive yarn. It provides comfort to the wearer and also retains heat within the environment without much loss. The

developed conductive yarn was placed wherever the heat is required. The heat was generated with DC power supply using 9V battery & 10 Ah power-bank (Figure).



Cotton based Heating Gloves

The temperature control was also provided with 3 different modes (low, medium and high) with voltage supply of 3.7V, 7.5V and 10V. The power supply using power-bank was found to be active for 10hrs, 8hrs and 4hrs respectively with the voltage change.

Heating garment

The heating garment was developed in which 2 power bank has been used for heating 3 pads. One at the back and 2 at front (chest part) shown in the Figure.



Heating Garment

This product can generate the maximum temperature of 45°C. There was a control switch that has 3 different mode of operation to adjust the voltage supplied to the heating pad. Thus the power can be controlled according to the heat required by the wearer.

Warming seat cover

The heating pads can be used in this product with some modification. This warming seat covers will provide the user better comfort when they work for long time on a chair. The product provides external warmth to their back bone and nerves and keep them more active and relief from back pains. (Figure).



Warming seat cover

The heating pads, developed with conductive yarns, were optimized to generate the temperature of 40-45°C. These smart textile heating pads can be used for developing heating garments, warming seat covers, warming baby towel, warm pads for knee pain etc. The major advantage of this product is to achieve high temperature from low voltage 5V, 2A power supply. The power bank can be used as the source of power supply.

2.2.4 Development of Composite Material Based Sanitary C Pad

A sanitary napkin/ sanitary towel/ sanitary pad/ menstrual pad, or pad is an absorbent item worn by a woman during menstruation or recovering from vaginal surgery, or Lochia (Post-birth Bleeding), after an abortion or in any other situation where it is necessary to absorb a flow of blood from the vagina. Menstrual pads are worn to absorb menstrual discharge (and thereby protect clothing and furnishings). Supply chain management and techniques for manufacturing hygienic sanitary pads is still lagging behind. Increasing urbanization, better living standard, nuclear families, needs of dual income families are important factors which have influenced to shift to modern use pattern among young girls/ ladies in India.

Scouring and Bleaching of Cotton

Scouring (Removal of wax, oil, fats materials present in the natural fibre) and Bleaching (Process for removing colouring substances (naturally occurred colour) from cotton fibre and improving whiteness index) was done treating 1.5 g of cotton fibre with NaOH, H₂O₂ and wetting agent.

Enzymatic Bleaching

It was observed that chemical bleaching is more effective than enzymatic treatment. Chemical treatment improves the absorbency and whiteness of cotton as compared to enzymatic treatment

Whiteness Index Test

Sample	L*	Hunter	CIE
Combernoil (Control)	87.48	80.97	14.87
Cotton 1 (2%NaOH)	92.61	89.21	60.05
Cotton 2 (4% NaOH)	90.90	87.27	58.73
Cotton 3 (6% NaOH)	89.23	85.07	52.44
Raw fabric (control)	87.87	82.28	29.82
Fabric (Chemical)	94.06	91.89	77.67
Fabric (Enzymatic)	87.26	81.62	29.62
Desi cotton (Short staple enzyme treated)	81.03	74.01	11.42

Chemical bleaching of banana fibre

After chemical bleaching absorbency and colour quality of fibre was improved. Absorbency time for banana fibre was 6.1 sec.



Characterization of raw material for sanitary C pads

Test name	Banana fibre	Wood pulp sheet	Combernoil	Absorbent cotton
Absorbency (sec)	6.1	5	2.1	2
Sink test (sec)	–	7	2.9	3.3
Water holding capacity (g/g)	–	–	25.5	28.8
Sulphated Ash content (%)	–	–	0.47	0.41

Banana fibre, absorbent cotton and fabric were tested as raw material for sanitary C pads. From above experiments, it is found that absorbent cotton and combernoil shows best result for the absorbency test. Absorbent cotton shows higher water holding capacity so it can be used for making of sanitary C pads. Sulphated ash content for both cotton sample was less than

0.5% so can be used for further experiments. Enzymatic bleaching for fabric shows good results with addition of wetting agent. Process can be optimized for the other raw materials. Banana fibre can be mixed up with cotton fibre to get a superabsorbent material for the sanitary C pads.

2.3 CORE AREA - III: CHARACTERISATION – COTTON AND OTHER NATURAL FIBRES, YARNS AND TEXTILES

2.3.1 All India Coordinated Research project on Cotton (Quality Research)

The samples under different National trials, were segregated and analysed on basis of UHML ranges. Mean values of entry of different centres was taken into account for the analysis. The X-axis of all the graphical presentations represents different entries.

- ❖ Majority of the samples were in UHML range of 25-31 mm.
- ❖ The samples were having UI equal to the minimum requirement

Br. 02a initial evaluation trial of *G. hirsutum* under irrigated condition

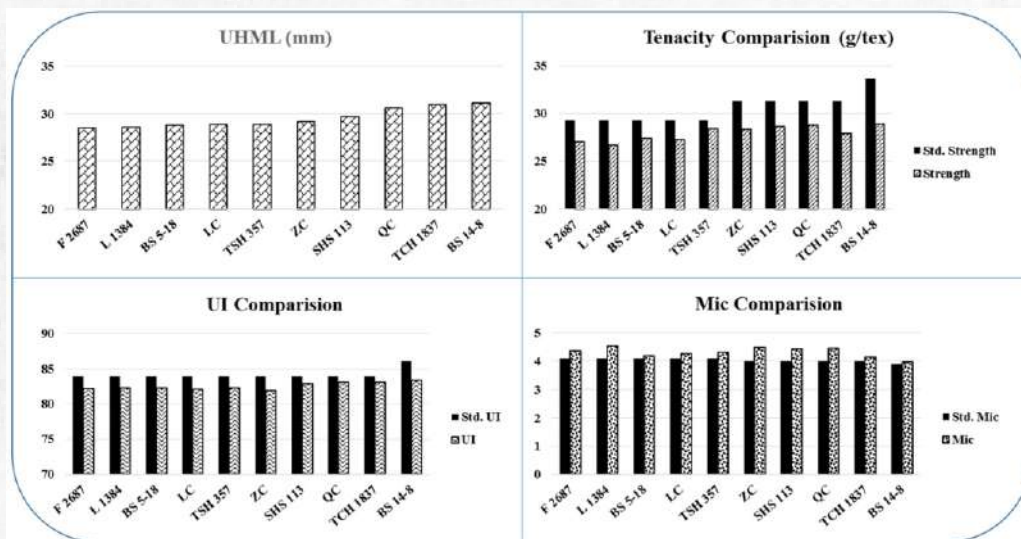

- ❖ The tenacity of the samples was either at par or marginally low compared to the minimum requirement.
- ❖ The micronaire values of all the samples were higher than the maximum required micronaire.
- ❖ Entry BS 418 (31.1 mm UHML, Tenacity 28.9 g/tex, Mic. 4.0, Uniformity Index 83) has performed well and was recommended for promotion.

Important observations

- ❖ *G. Barbardence* variety trial has resulted in

fibres with good strength, micronaire and uniformity

- ❖ Compact genotypes trial under irrigated conditions performed well in terms of strength and micronaire
- ❖ In *G. hirsutum* trial under rain fed conditions, the strength was marginally lower than the minimum requirement.
- ❖ Long linted *G. Arborium* trial resulted with good fibre length and micronaire.

2.3.2 Marker Fibres: A Tool for Traceability of Cotton Textiles

Zinc sulphide, with addition of suitable activator, like copper, silver, manganese exhibits strong phosphorescence is currently used in many applications, from cathode ray tubes through X-ray screens, to glow in the dark products. Bleached viscose fibres were used to synthesize the nano zinc sulphide as a template. 0.01N Copper sulphate was used as activator.

0.1 N Zinc acetate was used to treat viscose fibres followed by the treatment with 0.2 N sodium sulphide. After the treatment the fibres were analysed for the fluorescence in spectro fluorimeter. It was found out that copper doped zinc sulphide fibres has specific fluorescence in the range of 450 - 460 nm if it is excited in 340 nm incident light.

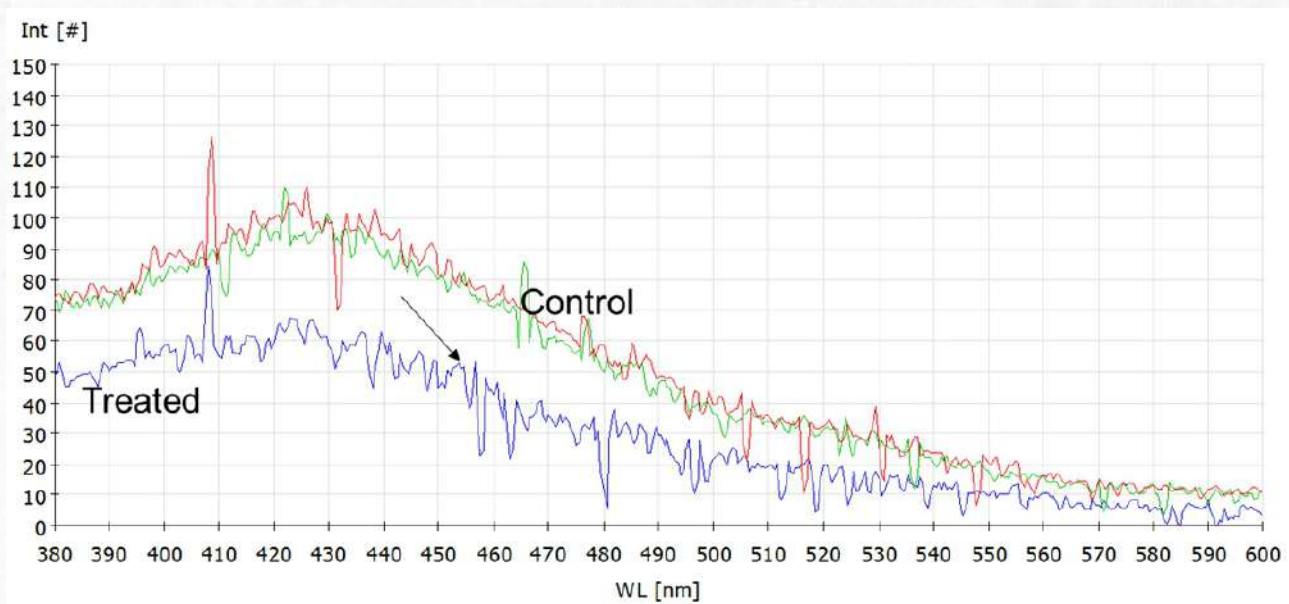

Fluorescence Spectra of Marker Fibres

2.4 CORE AREA - IV: CHEMICAL & BIOCHEMICAL PROCESSING AND BIOMASS & BY-PRODUCTS UTILISATION

2.4.1 Scale-up of a microbial process for degossypolization and nutritive quality improvement of cottonseed cake

Cottonseed cake is rich in protein and well known ruminants feed. However, the presence of gossypol and low level of lysine, an essential amino-acid make cottonseed cake unsuitable for non-ruminants feed applications. Gossypol is a toxic polyphenolic compound present in cottonseed cake. At ICAR-CIRCOT, a microbial process was developed for gossypol detoxification and lysine enrichment in cottonseed cake. The microbial process involves solid state fermentation of cottonseed cake with degossypolizing yeast cultures viz., *Candida tropicalis* and *Saccharomyces cerevisiae*. The degossypolized cottonseed cake had 70-80 % free gossypol reduction; 50-60 % bound gossypol reduction, 20-25 % increase in protein content and 10-15 % increment in lysine content. At GTC of ICAR-CIRCOT, Nagpur, batch fermentation was taken up to 50 kg per day using the batch fermentation facility.

However, in the present project, attempts were made to develop a pilot plant for continuous production of degossypolized cottonseed cake at 100 kg per day to replicate the model in industry. A 3D design of degossypolization pilot plant was developed for continuous production of degossypolized and nutritive enriched cottonseed cake with the capacity of 100

kg/day. The pilot plant consists of the following components.

1. A culture tank which adds the culture continuously to the grounded cottonseed meal
2. A raw material feed hopper continuously feed the grounded cottonseed meal into the mixer.
3. A culture blending tank or mixer that mixes the grounded cottonseed meal with the culture. The culture mixed cottonseed meal is fed to the fermentation vessel.
4. The fermentation vessel has two sub- screw conveyors systems.

It carries the culture added cottonseed meal under controlled and constant rate so as to retain the cottonseed meal for 24 hours. The constant mixing and retention of culture added cottonseed meal allows the growth of yeast culture, fermentation and degossypolization to take place. A fermentation vessel mounting stand was designed for pilot plant. The provisions are given to fix the components of degossypolization pilot plant in the stand.

2.4.2 Development of natural fibre based fragrance material for well-being

Different fragrance based materials have been available in the market. In most of the cases, synthetic fragrance materials are used either in gel or powder form. This is first time natural fibre has been used for control release of fragrance. Moreover, different kind of natural essential oils have been used for delivering fragrance.

A natural fibre based well-being fragrance packet has been developed. The packet consists of five layers of cotton nonwoven (gram per square meter 100) as core material. Fragrance based natural essential oil has been incorporated in the middle non-woven layer of the cotton. Oil infused in the cotton non-woven slowly wicks through the upper and lower non-

woven layers and the well-being smell of the active ingredients present in the essential oil slowly diffused in the surrounding atmosphere through the small pores of the sheath material. Non-woven cotton layers which have been used as the core material of the fragrance pack, act as a physical barrier in the way of diffusion of active ingredients, present in the oil. For the preparation of the core material of the said fragrance packet, apart from the cotton non-woven, layers of jute and banana non-woven also have been examined. However, oil infested in the layers of jute and banana nonwoven easily bleeds on the outside surface due to the lack of compactness in the non-woven structure. It is the major limitation for using those ligno-cellulosic fibres as essential oil holding material. On the other hand, grey cotton has hydrophobic pectin or thin waxy layer in its surface and have capability to hold the oil. As a result, it could diffuse the active ingredients of oil slowly through the layers resulting in control release mechanism of fragrance. As far as the sheath material is concerned, after different trials it has been optimised that around 2000ml/min air flow (related with porosity) has been satisfactory for the diffusion of fragrance species into the surroundings of the packet. For preparation of the sheath material of said well-being fragrance pack, banana paper was used as it meets the desired porosity level. Size of the packet also has been optimised.

As per our experiment, 15cm x 9cm pack size is standard for making the natural fibre based well-being fragrance packet. If the length of the pack is less, then there is an ample chance for some of the essential oil incorporated in the cotton non-woven, to leach in the outside paper material of the packet. Quantity of the essential oil requirement is also an addressable issue and in this direction, it has been optimised that at least 4 ml essential oil is required for getting satisfactory smell.

As per feedback of the end users, natural fibre based fragrance packet which has been produced by the above mentioned method is capable in releasing fragrance up to six to seven days in its surrounding atmosphere. We have also taken feedback report of the different persons regarding the intensity and the durability of the citronella based well-being fragrance. As per report, fragrance released from the packet is satisfactory up to seven days in the 25-30 sq. ft. area. In addition, very less no. of mosquitoes also have been visible in that measured area. However, after seven days, intensity of the fragrance is going down and after 20 days no fragrance come out from the pack. As per standard report of mosquito repellency, the said packet has shown 100% repellent against mosquitoes up to four days of continuous usage from opening the packet.



Natural fibre based fragrance pack for health and well-being

2.5 CORE AREA - V: ENTREPRENEURSHIP AND HUMAN RESOURCE DEVELOPMENT

2.5.1 Development of nanocellulose based edible coating for fruits and vegetables

Edible coatings are thin layers of edible material applied to the surface of food by dipping, spraying, or brushing in addition to or as a replacement for natural protective waxy coatings. Edible coating on fresh fruits and vegetables prolongs the shelf life by reducing quality changes and quantity losses through modification and control of the internal atmosphere of individual product. Further, edible coatings can carry active ingredients such as anti-browning agents, colorants, flavours, nutrients, spices, and antimicrobial compounds that can extend product shelf life and reduce the risk of pathogen growth on food surface. Biopolymers such as carboxymethyl

cellulose (CMC), guar gum and sodium alginate were studied to check their efficacy to form a stable emulsion with vegetable oil to prepare edible coating. Owing to the better water vapour resistance, stability and film forming properties of alginate based emulsion, nanocellulose-alginate based composite edible coating was formulated and whole pears were coated with it. The untreated and coated fruits were stored under refrigerated storage for a period of 30 days. Pears coated with NC-alginate emulsion retained better quality with less ripening and weight loss as compared to uncoated pears.

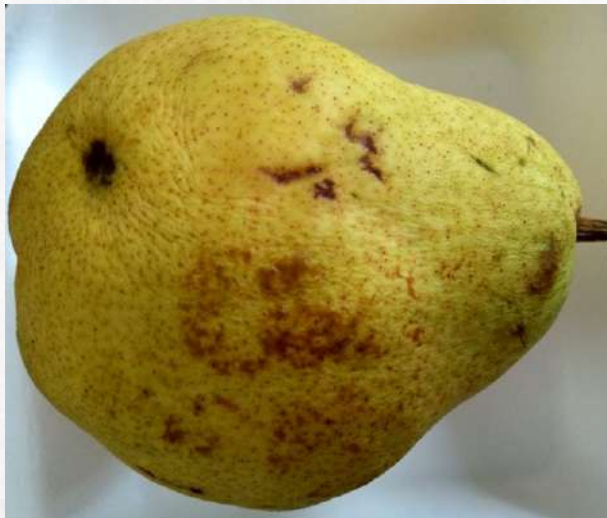

(a)



(b)

Pears at the end of 30 days refrigerated storage (a) uncoated (b) coated with nanocellulose-alginate based emulsion

2.6 EXTERNALLY FUNDED PROJECTS

2.6.1 Industrial Adoption of ICAR-CIRCOT's Paper Pulp Technology (Extramural)

ICAR-CIRCOT's security feature was successfully validated on Industrial scale at M/s. Bank Note Paper Mill (BNPM), Mysuru. Shri. K.G. Viswanathan, MD, BNPM visited ICAR-CIRCOT on 2nd January 2019 to see the facilities and to interact with the scientific team. This was

followed by the visit of a technical team from BNPM to ICAR-CIRCOT on 16-17 Jan 2019. Subsequently, this project was reviewed by DG, ICAR on 19th January 2019 at ICAR-CIRCOT, Mumbai. Dr. K. Alagusundaram, DDG, ICAR, Dr. P. G. Patil, Director along with Dr. N.

Vigneshwaran, PI of this project visited M/s. BNPM, Mysuru on 5th April 2019 to understand the impact of banana fibre pulp in their system and the requirement for the development of newer security features.

To overcome the problem faced during the mechanical cutting of banana fibres on a large scale, the research team from ICAR-CIRCOT visited the paper mill, M/s. Bindlas Duplux Limited, Muzaffarnagar, UP to carry out the enzyme pulping trial of banana fibres (Figure 2). About 100 kg of banana fibre was loaded in the pilot scale digester (without cutting of fibres) and cooked along with alkali for 4 hours. Once completed, the brown liquor was removed and washed with water. Then, it was neutralized with acetic acid followed by enzyme treatment of 2 hours to cut the fibres. This was followed by

washing and peroxide bleaching using hydrogen peroxide, sodium silicate and caustic soda. Then, the pulp was washed, squeezed and sun dried to form the pulp. This process was optimized to avoid the mechanical cutting of banana fibres.

For blending trials with cotton, the prepared banana fibre pulp was transported to M/s. Navsari Agricultural University. Also, a bale of combernoil was supplied to them. The pulp sheet was prepared from banana pulp alone and also in a blend proportion of cotton: banana (90:10). Figure 3 shows the photo of single and blended pulp sheets. This trial demonstrated the use of banana fibre pulp to blend with cotton pulp for production of high quality pulp sheet.



Figure 1. Project review by DG, ICAR on 19th January 2019.



Figure 2. Industrial processing of banana fibres for pulping at Muzaffarnagar during 7-11, June 2019.



Figure 3. Pulp sheet prepared from banana fibre and cotton: banana (90:10) blend

2.6.2 ICAR-CIRCOT-Agri-Business Incubation (ABI) Centre

ICAR-CIRCOT Agri-Business Incubation (ABI) Centre promotes incubation and business development in cotton and its by-products, conducts techno-entrepreneurial activities in cotton value chain for building prospective clientele and facilitates skill development in selected stakeholders related to cotton sector. During the current year three new entrepreneurs were admitted at ICAR-CIRCOT-

ABI Centre for incubation on technologies in Development of starch based film; Utilization of Rice Husk for particle board application; Preparation of bio-degradable products using agro biomass (banana fibres, rice straw, bagasse). Five specialized training programmes were conducted for incubatees and other trainees during the year 2019-20 by ICAR-CIRCOT-ABI Centre.

List of Entrepreneurs admitted for incubation

Sl. No.	Technology	Incubatee	Date of MoU Signing
1.	Utilization of Rice Husk for Particle Board Application	M/s. Fumalabs Pvt. Ltd., Gwalior	22 nd December 2018
2.	Preparation of bio-degradable products using agro biomass (banana, rice straw, bagasse)	M/s. Kothari Distributors, Hyderabad	3 rd January 2019
3.	Development of starch based film	M/s. Plantabase Ventures Pvt. Ltd., Mumbai	26 th February 2019



Rice Husk Particle board by M/s. Fumalabs Pvt. Ltd.



Bio-degradable products using agrobiomass by M/s. Kothari Distributors



Starch Film developed by M/s. Plantebase Ventures Pvt. Ltd., Mumbai



MoU signing with M/s. Plantebase Ventures Pvt. Ltd., Mumbai

2.6.3 Valorization of Cottonseed Meal: Extraction of Quality Protein for improving the Livelihood of Cotton Farmers (DST)

The project aims to optimize the extraction of cottonseed protein isolate (CSPI) from defatted cottonseed meal (CSM). Further, preparation of protein hydrolysate by achieving maximum degree of hydrolysis. For optimizing the recovery of the protein from cottonseed meal (CSM) different extraction methods viz. aqua-based extraction, alkali extraction, aqua based ultrasound-assisted extraction, aqua based homogenizer-assisted extraction, combination of alkali and ultrasound-assisted extraction and combination of alkali and homogenizer-assisted extraction were used.

In Aqua-based extraction, 2 factors namely incubation time for solubilisation of protein and aqua to sample ratio were optimized. In Ultrasound-assisted extraction (UAE), single factor experiments were conducted by using three factors i.e. time, frequency and temperature to determine the optimum conditions for extraction of cottonseed protein isolates (CSPI) from CSM. Homogenizer-assisted extraction were conducted by using two factors speed and time to achieve high protein recovery. Another greener way for extraction of protein using natural alkali

sources like spinach extract was tried but unable to achieve the good protein recovery as the pH of the extract was in between 7-8. pH more than 10 is found to play important role in extraction and solubilisation of protein in extracting media. Hence, alkali-based extraction was used and single factor experiments were conducted by using five factors i.e. sample to solvent ratio, Time, KOH, NaCl and Na_2SO_3 concentration to determine the optimum conditions for extraction of protein from CSM. Results showed alkali extraction followed by 95% ethanol (pH=7) and citric acid precipitation (at isoelectric point of CSM protein) resulted in maximum protein recovery than others. CSM proteins have maximum solubility at alkaline pH, NaCl also contribute in CSM protein extraction and

Na_2SO_3 reduces gossypol content in CSPI by oxidation. Optimized value of supernatant to ethanol is 1:2 ratio (v/v) incubated at -20°C for 1 hr. and ethanol was recovered by distillation. After precipitation, protein was recovered by centrifugation. In pl precipitation, protein precipitates out when net charge is zero, cottonseed has their pl at pH 4.5 adjusted using 0.05M citric acid. Both the precipitation methods not only reduce production cost and time but also improve the quality and quantity of CSPI. In future, development and optimization of process for production of cottonseed protein hydrolysate using different enzymes will be carried out. The effect of extracted protein will also be evaluated for the cytotoxicity and genotoxicity.

2.6.4 An Inclusive Agribusiness Model for Sustainable Cotton Marketing in the State of Maharashtra (NASF)

The aim of the project is to assess the existing market mechanism of the cotton farmers in the state of Maharashtra for its sustainability and profitability, study the price quality relations and evaluate the harvesting and post harvesting practices of cotton farmers in relation to price quality linkages in cotton market and examine the utilization pattern & market for the cotton by-product and to come up with an inclusive agri-business model to improve the profitability of the cotton farmers and mechanism needed for its implementation. Six major cotton growing districts and also representative of the different regions of Maharashtra viz., Jalgaon (Khandesh), Aurangabad & Parbhani (Marathwada), Yavatmal & Amaravati (Vidharbha), and Ahmednagar (Western Maharashtra) have been identified for the study.

During 2019-20, the primary survey was carried out in the districts of **Aurangabad** (Tehsil: Paithan, Khuldabad, Gangapur and Turkabad),

Amaravati (Tehsil: Teosa, Chandur Bazar, Daryapur and Warud) and **Jalgaon** (Tehsil: Jalgaon, Dharangaon, Pachora, Badegaon, Jamner and Chopda) and primary data was collected from over 320 farmers covering small, medium and large size farm holdings; Irrigated and rain-fed cultivation; BCI cotton and Non BCI cotton growing farmers. During the survey the traders and ginners were also covered. The cotton samples were collected from farmers, traders and ginners for evaluation of the quality and link it with the prices paid for the crop. The major observations based on the survey and preliminary analysis are

- ❖ There is a substantial increase in the total area under cotton cultivation in the surveyed districts. In Aurangabad, it's predominantly rainfed, in Amaravati district cotton was grown with intercrop (Tur), whereas in Jalgaon it's raised as sole crop, with less seed rate and irrigated through drip system.

- ❖ Farmers Producer Companies are operational bringing together Organic farmers group in limited area. In Amaravati and Jalgaon districts, almost 25-30 percent of the farmers are seen adopting the Better Cotton Initiative (BCI) programme implemented by different agencies.
- ❖ Mechanization of the field operation has an effect of lowering the cost of production as evidenced in the Jalgaon district.
- ❖ Though different market channels are available, farmers prefer village traders as they get the cash payment immediately and also avoid transportation cost. Delays in the payment and methods of price determination are deterring the farmers from selling cotton in the APMCs.
- ❖ Though quality is prime determinant in fixation of price, it is predominantly subjective and decided by the graders.
- ❖ There are fewer cases of commercial utilization of the cotton stalks: part of the stalks are used as Household fuel and the remaining are burned. Few farmers incorporate the cotton stalks in the field with the help of rotavator.
- ❖ Harvesting of cotton is completed in three or four pickings. Quality of the cotton harvested in first two pickings are superior when compared with that of last pickings. As per the farmers price difference between different qualities of cotton is nominal. Hence they do not separate and sell each quality separately.
- ❖ Length, strength, moisture content, trash and colour are the major factors considered by the traders while fixing price of cotton.



Sale of cotton to local traders, Amaravati Dt.



Discussion with farmers in Warud Tehsil, Amaravati Dt.

2.6.5 Technology Incubation – RAFTAAR Agri-Business Incubation (DAC&FW)

RKVY Division of Ministry of Agriculture has sanctioned CIRCOT to work as Agri Business Incubator under RAFTAAR (Remunerative Approaches for Agri and Allied Sectors Rejuvenation) scheme from 31st January 2019. Since then CIRCOT has got a new wing with which it can expand its reach to Agriculture and Allied Sectors.

CIRCOT-RKVY-RAFTAAR-ABI provides a platform to raw talent not only to materialize their innovative ideas in agriculture and allied sectors but also to commercialize them. Through this platform individuals/startups with innovative ideas can have access to CIRCOT's experienced expertise and standard testing laboratories to bring their ideas in reality. All necessary nurturing, mentoring and financial grant in aid will be made available through this platform. This wing of CIRCOT will focus on strengthening the Agriculture sector which is the back bone of Indian Economy by building a new line of Agri innovators and agri-entrepreneurs. This line will provide new remunerative approaches of Indian Agriculture which will attract Indian Youth towards Agriculture.

CIRCOT-R-ABI will facilitate incorporation of entities for all viable business ideas by the interns. Selected interns will be eligible to apply

for Idea / Pre-Seed stage funding of grant in aid up to Rs. 5 lakhs per startup for converting his/her innovative idea into prototype/product. Seed Stage Funding scheme provides Grant in aid to Startups. Under this scheme financial assistance of maximum up to Rs. 25 lakhs will be granted to potential startups that have a Minimum Viable Product (MVP) based on innovative solutions/ processes /products/ services/ business model in agriculture and allied sectors.

This Scheme covers below focus areas like- Pulp, Paper & Packaging, Precision Farming, Food processing, Agri Extension Education, Post-Harvest processing, Agriculture Biotechnology, Waste to Wealth, Farm Retailing Supply Chain Management, Internet of Things (IOT), Farm Mechanisation, Animal Husbandry, Green Composite, Briquetting & pelleting, Natural Resource Management, Agri clinic & Farm Health Services, Cotton and other Natural Fibres, Sustainable Agri/Organic Farming, Nanotechnology Application in Agriculture, Agri Input Tools & Technology etc.

As per the Guidelines of RKVY-RAFTAAR, the CIRCOT-R-ABI centre functions under continuous guideline & supervision of RAFTAAR incubation committee (RIC).

CIRCOT-RAFTAAR Incubation committee (RIC)

Sr. No.	Name	Designation	Role In RIC	Contact detail
1	Dr. P. G. Patil	Director, ICAR-CIRCOT, Mumbai.	Chairman (Head of the Institution)	Email ID: pgpatil266@gmail.com Mobile No: 09022557169
2	Mr. Ramesh. R Kadam	RTD, General Manager, Bank of India.	Member (Representative of Bank)	Email ID: Rameshkadam08@gmail.com Mobile No: 09422845204
3	Dr. G. R. Anap	Former International Cotton Consultant, World Bank Project (Africa).	Member (Domain Expert from Industry)	Email ID: dr.anap@jadhaogear.in Mobile No: 9821209694
4	Prof. (Dr.) V. D. Gotmare	Associate Professor, Department of Textile Manufacture, VJTI, Mumbai.	Member (Domain Expert from Academia)	Email ID: gotmareved@gmail.com Mobile No: 09833721022
5	Prof. (Dr.) A. S. Vastrad	Professor and Dy. Director Student Welfare, University of Agricultural Science (UAS), Dharwad.	Member (RKVY Knowledge Partner nominee)	Email ID: asvastrad@gmail.com Mobile No: 09448194694
6	Shri. D. B. Bote	Joint Director (Soil Conservation), Commissionerate of Agriculture, Pune.	Member (State representative from the state Department of Agriculture)	Email ID: dnyaneshwarbote@rediffmail.com Mobile No: 09422384384
7	Dr. N. J. Thakor	Former Dean, College of Agricultural Engineering and Technology, Dr. Balasaheb Sawant Konkan Krishi Vidyapeeth, Dapoli.	Domain Expert (Invitee) CIRCOT-R-ABI)	Email ID: nayan07@gmail.com Mobile No: 09420906951
8	Dr. Ashok Kumar Bharimalla	Senior Scientist & Head I/c., TTD, ICAR-CIRCOT, Mumbai.	Member Secretary (Principal Investigator) - Chief Executive Officer (PI-CEO), CIRCOT-R-ABI)	Email ID: ashokbhari72@gmail.com Mobile No: 09702878249

As the start-ups incubated under this scheme covers a wide range of sectors, continuous mentoring and monitoring of Start-up progress shall be done. For wide publicity of the scheme and to reach more number of agri-innovators CIRCOT-R-ABI team developed website, designed information brochures which were inaugurated by Mr. Sushilkumar (IAS),

Additional Secretary, DARE on 1st May 2019. The first cohort of the scheme started on 6th April 2019. During the first cohort fifteen (15) agri-startups were incubated at CIRCOT-R-ABI to develop and commercialize their products and proposal submitted to DoAC & FW for grant in aid support of Rs. 5 lakhs –Rs. 25 Lakhs

Sectorwise start-ups

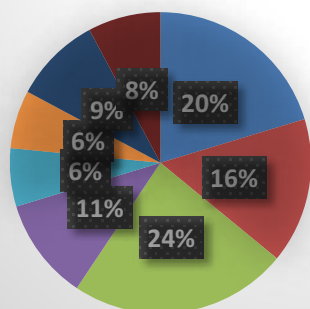

Textiles and technical textiles(13)
Value addition to agri-waste(10)
Food processing(15)
Agro processing machoneries(7)
Agro services (4)
Packaging(4)
Farming(6)

Applicants selected for Pre-seed stage funding (up to Rs 5 Lakhs)

Sr. No.	Incubatee	Technology Name
1	Mr. Ravindra Prallhad Nemade	Cotton processing
2	Mr. Aniruddh Dattatray Balvan	Value addition to mango based agri-residue
3	Mr. Amar Babasaheb Shirsath	Cotton picker
4	Mr. Rajendra Vasant Pawar	Multipurpose farm equipment
5	Mrs. Meena Manik Gaikwad	Eco-friendly finishing of Khadi fabric

Applicants Selected for Seed-Stage Funding (up to Rs. 25 Lakhs)

Sr. No.	Incubatee	Technology Name
1	Mr. K. K. Anand	Natural rubber-based garden pots
2	Dr. Prakashkiran Suryakant Pawar	Cost effective and accurate Lysimeter
3	Mr. Sandeep Nikam	Value addition to agri-biomass
4	Mr. Pratik Gaikwad	Innovative paper carry bags
5	Ms. Ashwini Adhikrao Jadhav	Herbal tea products
6	Ms. Manjusha Madhukar Patil	Chemical free ginger and turmeric oil extraction
7	Ms. Priyanka Navin Choksi (Wadekar)	Preservative free spices mix with extended shelf life.
8	Mr. Ajit Dinkar Jadhav	Innovative integrated farming
9	Mrs. Pratibha Chandrakant Dange	Real time temperature monitoring device for reefer containers
10	Mr. Suresh M. Mallesha	Nano finished sleeping bags

❖ Website of CIRCOT-R-ABI

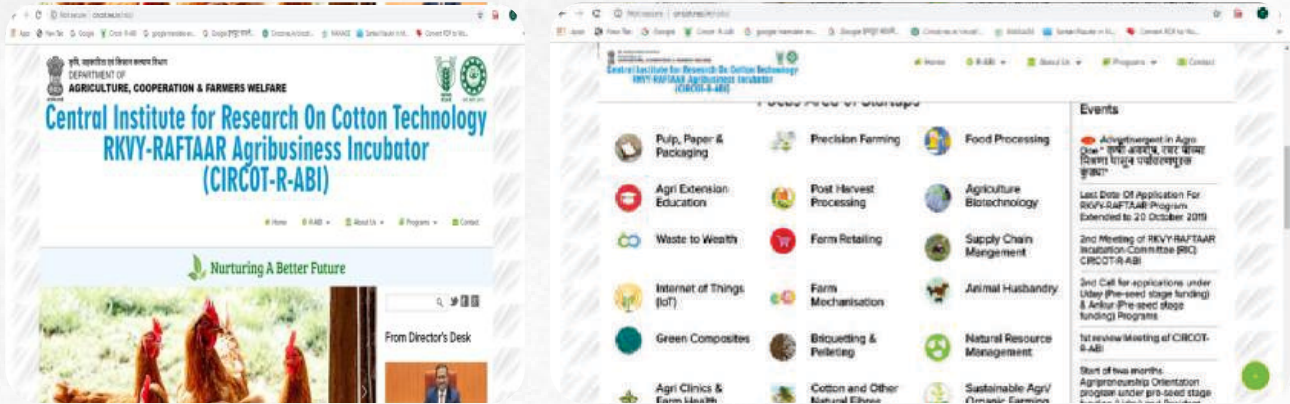

❖ The team developed CIRCOT-R-ABI website, designed information brochures and application forms for pre-seed stage funding program and seed stage funding program were inaugurated by Mr. Sushilkumar (IAS), Additional Secretary, DARE on 1st May 2019.



Pre-Stage Funding Program (Uday) Brochure



Seed Stage Funding (Ankur) Brochure



❖ The first RIC was held on 22nd June 2019.



❖ The First Review Meeting held on 23rd August 2019.



❖ The Second RIC was held on 17th September 2019.



❖ Visit to incubatee M/s Rubber Engineers, Thrissur, Kerala for development of naturally rubberized fibre reinforced garden pots.



❖ Visit to incubatee 'M/s Navkruti industries' for Eco- Friendly Dyeing and Finishing Cotton and Handloom fabric.



❖ Incubatee M/s FNV Pack Development of products in CIRCOT-RABI.



Products developed by CIRCOT-R-ABI Incubatees

<p>M/s. Douce Solution LLP, MH</p> <p>Value addition to mango kernel by product of mango processing industry.</p>	<p>M/s. Parvati Agrotech, MH</p> <p>Hand operated cotton picking machine</p>	<p>M/s. Greenmove Agrotech Pvt Ltd, MH</p> <p>Multipurpose farm equipment</p>	<p>M/s. Navkruti Industries, MH</p> <p>Eco-friendly finishing of textile</p>	
<p>M/s. Rubber Engineers Enterprise, Kerala</p> <p>Fiber reinforced Natural rubber-based garden pots</p>	<p>M/s. Green Prosperity Innovations, MH</p> <p>Cost effective and accurate lysimeter</p>	<p>M/s. FNV Agro Pack LLP, MH</p> <p>Value addition to agri-biomass</p>	<p>M/s. Udayprastha Industries, MH</p> <p>Fiber reinforced Paper (FRP) Garry Bag</p>	<p>M/s. Sambra Agro Industries, MH</p> <p>Herbal healthy drinks</p>
<p>M/s. Mystic Herbal, MH</p> <p>Chemical free ginger and turmeric oil extraction</p>	<p>M/s. Swamiraj Exim, MH</p> <p>Preservative free spices mix with extended shelf life</p>	<p>M/s. Prayas Agro Farm, MH</p> <p>Innovative integrated farming</p>	<p>M/s. Techno expert Solution, MH</p> <p>Real time temperature monitoring device for reefer containers</p>	<p>M/s. Shree agro invent-tech private limited, MH</p> <p>Nano-finished sleeping bags</p>

Glimpse of events

Inauguration program for brochure

1st review Meeting of CIRCOT-R-ABI

Workshop attended

Visit to M/s Rubber Engineers

Visit to M/s Navkruti industries

2.7 CONSORTIA RESEARCH PROJECT (CRP) ON NATURAL FIBRES

2.7.1 Utilisation of Ligno-Cellulosic Fibre Based Biomass as Renewable Energy for Rural and Industrial Applications

A large amount of cotton stalk generated every year in India has the potential to promote industrialization in rural areas thereby creating employment and increase farm income. This project is aimed to develop viable logistics for supply of cotton stalks for pelleting, briquetting and power generation, development of process parameters for preparation of premium grade pellets from cotton stalks, study of suitability of cotton stalk pellets for different industrial applications and development of Indian standards for biomass pellets and briquettes.

A. Torrefaction of Cotton Stalk Pellets

Torrefaction is a thermal pre-treatment technology for improving the suitability of biomass for renewable energy generation and heating. The torrefied biomass possesses high energy density, hydrophobic, compactable, and grindable, and has a lower oxygen-to-carbon ratio. Torrefaction of biomass is mostly carried out in temperature ranges of 200°–300°C and performed at atmospheric pressure in the absence of oxygen. In the torrefaction process, initially, water due to chemical reactions is removed through a thermo condensation process at temperatures between 160°C and 180°C and results in the formation of CO₂. At temperatures of 180°–270°C, the reaction is more exothermal, and the degradation of hemicellulose continues. At these temperatures, biomass begins to brown and give off additional moisture, CO₂ and large amounts of acetic acid with some phenols that have low energy values. During torrefaction, the major decomposition reactions affect the hemicellulose. Lignin and cellulose also decompose in the range of temperatures at which torrefaction is normally carried out, but to a lesser degree. Torrefied biomass retains most of its energy and simultaneously loses its hygroscopic properties. At about 280°C, the

reaction is entirely exothermic, and gas production increases, resulting in the formation of carbon monoxide, hydrocarbons like phenols and cresols, and other heavier products. For torrefaction, process temperatures over 300°C are not recommended, as these may lead to extensive devolatilization of the biomass due to the initiation of the pyrolysis process.

Torrefied pellets are expected to have distinct applications in power generation and help coal-based utilities to reduce their emission levels and comply with increasingly stringent regulations. Co-firing coal with torrefied pellets requires little-to-no retrofit of the existing power plant and, therefore, can offer a low-cost solution. There are two potential pathways i.e. upstream or downstream for production of torrefied pellets. In the upstream process, pellets are prepared from torrefied biomass while in the downstream process the torrefaction of pellets are carried out after pelletisation process. A successful upstream torrefaction process can potentially produce highly dense and durable torrefied pellets. Whereas downstream torrefaction process eliminates the need for additional grinding and pelletizing capacity, while minimizing plant-wide contamination due to dust generated from the processing of torrefied biomass. The limitation of downstream integration includes the potential compromise in pellet quality, especially a loss in strength and density.

During the reported period, preliminary trials were conducted at GTC for preparation of torrefied pellets from cotton stalks. In this work, downstream integration process was adopted for preparation of torrefied pellets. Initially, cotton stalks were shredded to about 10-12 mm particle size using tractor drawn chipper. Thereafter, shredded biomass was milled to 3

mm particle size using a hammer mill. The milled material was torrefied using Pyrolysis Pilot Plant facility available at M/s. Vidarbha Sales, Nagpur. The milled material was torrefied at 280 °C temp, atmospheric pressure for 30 min under in absence of oxygen. Exposure of biomass to elevated temperatures

results in thermal degradation of its structure and loss of mass. The duration of the torrefaction process was adjusted to produce friable, hydrophobic and energy-rich enhanced biomass fuel. The characteristics of initial biomass, untorrefied and torrefied pellets are presented in Table 1.

Table 1. The characteristics of initial biomass, untorrefied and torrefied pellets

TF Temp (°C)	TF Time (min)	Initial Biomass conditions			Un-torrefied Pellet Characteristics			Torrefied Pellet Characteristics		
		BD (kg/m ³)	HHV (Kcal/kg)	Ash (%)	BD (kg/m ³)	HHV (Kcal/kg)	Ash (%)	BD (kg/m ³)	HHV (Kcal/kg)	Ash (%)
280	30	150	3750	7.5	580	3800	7.4	650	4500	4.5

It can be seen from Table 1 that the Bulk Density (BD) and High Heating Value (HHV) of the torrefied pellets have increased to 650 kg/m³ and 4500 kcal/kg, respectively as compared to 580 kg/m³ BD and 3800 kcal/kg HHV, respectively of the un-torrefied pellets. The torrefaction process also reduces the ash content of torrefied pellets to 4.5% from 7.4% of the untorrefied pellets. The reduction in ash content and increase in HHV in the torrefied pellets occurred mainly due to evaporation on volatile matters. The cotton stalk pellets produced here were able to meet many of the requirements for the highest quality class of pellets made from thermally treated non-woody biomass such as bulk density (>600 kg/m³), durability (>97.5%, and ash content (<5%) and HHV over 4200 kcal/kg.

B. Refinement of Continuous Feeding Pellet Stove

With the increase in commercial LPG prices and awareness about renewable energy, restaurants are switching over to pellet stoves, a cheap alternative for cooking. The commercially available pellet stoves are developed in a manner such that it allows burning of proprietary pellets having ash content ≤1%. Cotton stalk pellets having higher

ash content in range of 6-8% are not being utilized in these pellet stoves as it tends to choke due to the ash collected in the stove. The research in this line at ICAR-CIRCOT has established that cotton stalk pellets have calorific value of about 4000 kcal/kg and can prove to be a good and inexpensive alternative to costly proprietary pellets. This technology has been evaluated extensively at M/s. Sai Restaurant, Pratapnagar, Nagpur for cooking of snacks for 3 months. During the reported period, commercially available continuous feeding pellet stoves have been refined and fine-tuned based on large scale trials.

C. Transfer of Technology Pellet Stove

'ICAR CIRCOT Pellet Stove' technology was transferred to M/s. Vidarbha sales, Nagpur for commercialization and marketing. Memorandum of Understanding (MoU) for transferring of the technology was signed on occasion of 96th Foundation day of ICAR-CIRCOT on December 03, 2019. It is expected to pick up the sale of this product in the market.

Green Crematorium

Many Municipal Corporations and Zilla Parishads have shown interest in purchase of

'ICAR CIRCOT Green and Rapid Burning Crematorium Technology', which was transferred to M/s. Vidarbha sales, Nagpur for commercialization and marketing.

Hon. Shri Nitin Gadkari, Minister of Road Transport & Highways, Micro, Small & Medium Enterprises, Government of India has personally visited and enquired the 'ICAR CIRCOT Green and Rapid Burning Crematorium Technology' exhibited at Agro-vision 2019.

Nagpur Municipal Corporation, Nagpur has installed an ICAR-CIRCOT Crematorium at its Ambazari Crematorium, Nagpur. They have cremated about 200 bodies in last 15 months using this set up. They have issued a certificate stating that ICAR-CIRCOT Crematorium is successfully working for last 3 months and it is saving about 50% expenditure on cremation. Also, it is emitting much lesser pollutants in the environment as compared to traditional fire wood based cremation.



Hon. Minister Shri Nitin Gadkari visiting the 'ICAR CIRCOT Green and Rapid Burning Crematorium Technology' at Agrovision 2019 at Reshim Bag Nagpur

Linkages have been created among the farmers, biomass suppliers and manufacturers of pellets and briquettes across various states of India.

Cotton Stalk Supply Chain Logistics

Technological support was provided to 6 group of farmers in two villages (*Patansawangi and Mohopa*) of district Nagpur for supply of cotton stalks using logistics developed in this project. These groups collected about 5000 tonnes cotton stalks from their villages and supplied the material to a nearby briquetting plant.

10 Skill Development Programmes of 4 days each were organised for about 300 farmers of Maharashtra for increasing farm income through value addition of cotton stalks and other crop residues.

15 awareness programmes and workshops in districts of Wardha and Nagpur were organised for collection and use of cotton stalks for briquetting, pelleting and power generation.



Group photos of farmers of a skill development programme and awareness programme organised by CIRCOT, Nagpur to show case technologies developed under this project

2.7.2 Preparation of Nano Lignocellulose and its Incorporation in Polymer Composites for Improved Performance

The biomasses from banana pseudostem fibres, sugarcane bagasse and cotton wastes were used for the production of paper plates and other kitchen utensils without any binders. To impart hydrophobicity, commercially available bio-oil was evaluated for coating. Though it gave very good hydrophobic property, the used material is imported, based on food-grade fluorocarbon polymer and also very costly (Rs. 1,550 per kg). As an alternative, Bee's wax was evaluated for coating purpose. The bee wax was emulsified and used as a coating agent, both by spray coating and by applying using a brush. Figure 1 shows the paper plates coated with the Bee's wax (Figure 1).



Figure 1. Banana pseudostem fibre based kitchen utensils

Since the cost of Bee's wax is around Rs. 1,000 per kg, sugar cane wax (Rs. 300 per kg approx.) was evaluated as a substitute for coating on the surface of paper plates to impart

hydrophobicity. The protocol of ultrasonication and high shear homogenization was optimized to form the emulsion of sugarcane wax. The formed emulsion was sprayed on the surface of paper and allowed to dry. Two layered coating was done to achieve the required amount of hydrophobicity. Figure 2 shows the paper sheets coated with sugar cane wax. Out of the two different grades of sugarcane waxes, Naturowax GB01 and Naturowax GB11, received from M/s. Godavari Biorefineries, Naturowax GB01 performed better in terms of uniform coating. The production capacity of this sugarcane wax by M/s. Godavari Biorefineries is 250 tonnes per annum. Hence, there will not be any problem in supply chain.



Figure 2. Hydrophobicity of sugarcane wax coated paper.

The banana fibre composite panels were prepared with the support from the Incubatee

of ICAR-CIRCOT-ABI, Mr. Sandip Nikam and were used to panel the Conference hall of the Institute. The panels were prepared using cut banana fibres by hot press method. A commercially available bio-degradable glue was added to the panel for better binder. Colours were imparted to the fibres by dyeing process. Different designs / patterns in banana fibre composite panels were produced by the use of dried flowers and a demonstrative panel was fixed in the Director's room (Figure 3). This was followed by a complete panelling in the conference hall. Subsequently, a novel bio-based glue formulation was developed by ICAR-CIRCOT & demonstrated to replace the commercial bio-degradable glue.



Figure 3. Banana fibre composite panel in Director's Room

2.7.3 Eco-Friendly Method of Preparing Absorbent / Surgical Cotton from non-spinnable cotton

A new enzymatic Process was developed using a new strain *Aspergillus niger*. This organism was isolated from Banana pseudostem. For fermentation, the substrate used was Banana pseudostem: Cottonseed Hulls: Cottonseed Meal in the ratio of 60:30:10. The spores of fungus (*A. niger*) was inoculated in the autoclaved substrate and incubated for 10 days. After 10 days, the fermented substrate was extracted with pure water in the ratio of 1:10 and the crude enzyme used for absorbent cotton preparation.



Extraction of Enzyme



Extracted enzyme

Estimation of enzymatic activity

The enzymatic activity (Cellulase and Pectinase) was estimated in the *A. niger* and *P. flabellatus* crude enzyme extract. The results are shown in Table 1.

Table 1. Enzyme activity of fungal extract

Fungus	Enzyme activity	
	Cellulase (FPU)	Pectinase (U/ml)
<i>A. niger</i>	61	251
<i>P. flabellatus</i>	37	128

Optimization of absorbent cotton preparation using *A. niger* crude extract

The temperature, time and pH were optimized. Hence, further process were carried out at room temperature (30 to 40°C) for absorbent cotton preparation. Even at 50°C, the absorbency is 2sec, it was consider to carry out the process at room temperature (RT) as no temperature is required for the treatment and not much variation in absorbency time between RT and 50°C or above, as shown in the Table 2. The pH in the crude extract was 5.0. The same pH was giving better result compare to other pH levels on optimization. It is also found that the processing time of 45-60 minutes was giving good results.

Table 2. Effect of temperature on absorbency of short staple cotton

Temperature (°C)	Absorbency (seconds)
40	2
50	2
60	4
70	4
80	3
Room temperature (30 °C)	3

For concentration optimization, 5 g sample treated at 60, 70, 80, 90 and 100 ml of enzyme extract and make up with distilled water to 100 ml, the process carried out at room temperature (30±2 °C), time of treatment 60 min, with 0.05 % wetting agent. All the process carries out in shaking water bath at pH 6.0. It was found that at 80 ml of enzyme, it gives good

absorbency for shot staple cotton. The absorbency recorded was 3-4 seconds.

Similar work has been carried out to optimize the time also. The treatment was carried out at 15 min, 30 min, 45 min and 60 min and found that at 30 min it gives a good result. The absorbency at different temperature is shown in the below Table 3.

Table 3. Optimization of treatment time

Time (Minutes)	Absorbency (seconds)
15	2
30	2
45	4
60	4

Under optimized conditions, similar work has been carried out using the enzyme extract of *A. niger* and treated with 5g of different raw material (linters, combernoil and short staple cotton) and evaluated the absorbency.

Table 4. Effect of different raw material on absorbency by enzymatic method

Raw material	Absorbency (seconds)
Short staple cotton	2
Linters	2 (but not sink)
Combernoil	3

Using the developed enzyme, a training was carried out to transfer the technology to the rural women self-help group. About 30 women participated in the programme.



Training for Rural Women at Amravati

2.7.4 Sustainable Green Technology for Dyeing of Cotton

An industrial level scale up trial for salt free dyeing was conducted with 1300 metres of woven fabric at M/S Gini Silks, MIDC, Tarapur. Four different shades viz orange, light orange, light blue and beige were produced using remazol class of reactive dyes and the fabrics were finished with easy to iron finish. The dyeing was uniform with acceptable fastness properties.



A stakeholder's workshop was organized at Tiruppur on 1st March 2019 in collaboration with AIC-NIFT-TEA, Tiruppur Exporters Association (TEA), Dyers Association of Tiruppur (DAT). 70 industries participated. One MOU was signed with NIFT-TEA for popularising salt free dyeing technology.



A Non-disclosure agreement (NDA) was signed between ICAR-CIRCOT and SRG Apparels for undertaking industrial level trial for salt free dyeing technology. Initially, the required knitted fabric was scoured and bleached for undertaking the trial. After that five different

trials using salt free dyeing technology were carried out with intermediate testing and adjusting the recipe. A control dyeing experiment was also conducted using conventional dyeing method. Simultaneously, laboratory level dyeing experiments were also conducted. Out of these trials, the following points emerged.

The depth dye shade got out of salt free dyeing technology is higher in the case of medium dye shades of 2-4% compared to conventional dyeing method where 70 gpl of salt was added during dyeing. For dark shades i.e. 5% and more shades, the depth of colour obtained was approximately 20 % lower compared to conventional dyeing method. In order to solve this problem, the recipe for dyeing has been modified and given to SRG apparels and the trials are still going on.



A new salt free dyeing technology was developed using cationic polymer. By using the technology, cotton fabric was dyed with both Chloro triazine and vinyl sulphone based reactive dyes. The newly developed process provided similar dyeing shades as that of already developed one. The advantage of new process is that the total organic carbon (TOC) and total nitrogen (TN) values of the effluent are 3 times lesser than the already developed one. The industrial trial of the developed process is underway.

2.7.5 Value Addition to Banana Pseudostem

In India, banana is one of the important fruit crops and is cultivated on about 8 lakh hectare area (Horticulture Statistics Division, GoI, 2017). Huge quantity of biomass (pseudostem, leaves, suckers, etc.) is generated after harvesting of banana fruits. Presently, this biomass is discarded as waste or used partially. On an average about 60 to 80 t/ha of the biomass is pseudostem alone, which presently is absolute waste and does not find any commercial applications. In past, some researchers have successfully demonstrated use of banana pseudostems for extraction of fibres. In some cottage industries, fibres are being used for preparation of handicrafts. The full-fledged utilization of available pseudostem (50 million tonnes) for fibre extraction would generate 0.5 million tonnes of fibres annually. For widening the application and creation of

supply chain, further processing of fibre into yarn or other products and up to end use is necessary. Therefore, at ICAR-CIRCOT, we have undertaken work on development of spinning machine for banana filament fibre.

Accordingly, the machine has been designed and fabricated. The machine has two parts; feeding and spinning. Feeding of banana fibres is carried out manually. Spinning is operated by 0.5 hp single phase motor, speed of which can be controlled with the help of variable frequency drive (VFD). Different counts of yarn could be realized through variation in the amount of fibre feeding as well as quality of fibre. Developed banana fibre yarn could be utilized for making various products in home furnishing, agro-textile, etc. The developed banana fibre yarn is shown in Fig. 1.



Figure 1. Banana fibre yarn developed at ICAR-CIRCOT

2.7.6 Development of Nanocellulose Based Polymer Composites for Technical Application

Biodegradable composite films containing starch (6%), glycerol (3%) and PVA (5.4%) were developed using solvent casting method earlier. Though the developed films showed improvement in mechanical properties over starch films, further improvement was needed to compete with synthetic packaging materials. Nanocellulose, a novel material derived from cellulosic biomass is gaining considerable attention as an emerging green nano-

reinforcement, to obtain biocomposites with new functionality at relatively low cost. Thus, experiments on reinforcement of nanocellulose from cotton linters and other additives to starch-based biodegradable film were conducted. Total 17 experiments were formulated using central composite design (3-factors, 5-levels) of response surface methodology to study and optimize the effect of independent variables (nanocellulose %,

glycerol %, and PVA %) on product responses (Table 1). The starch content was kept constant at 6 %. As per design, 17 films were prepared and analysed for their tensile strength, elongation, water vapour permeability, bursting strength and tearing strength (Results are shown in Table1).



Figure 1: Nanocellulose reinforced starch based films prepared using 17 runs

Table 1: Central composite design showing experimental data of effect of independent variables on product responses

Independent variables				Responses				
Runs	Nanocellulose (%)	Glycerol (%)	PVA (%)	Tensile strength (MPa)	Elongation (%)	WVP (g/m.s.Pa)	Bursting strength (kPa)	Tearing strength (mN)
10	0.6	3	1	8.5	28.8	8.3×10^{-10}	440.3	350
11	0.2	2	1	4.9	14.5	10.6×10^{-10}	562.1	288
1	0.4	1.5	0.75	2.3	8.3	13.9×10^{-10}	400.4	220
8	0.8	2.5	1.25	8.9	32.1	7.9×10^{-10}	626.3	350
7	0.8	1.5	1.25	6.8	20.9	10.3×10^{-10}	430.7	310
5	0.4	1.5	1.25	4.6	13.9	10.9×10^{-10}	631.7	280
3	0.8	1.5	0.75	2.9	8.6	12.7×10^{-10}	376.4	240
2	0.4	2.5	0.75	3.8	10.2	11.6×10^{-10}	595.4	260
17	0.6	2	1	7.0	22.0	10.0×10^{-10}	297.9	320
16	0.6	2	1	7.1	22.6	9.6×10^{-10}	320.3	330
4	0.8	2.5	0.75	5.3	15.9	10.5×10^{-10}	589.3	290
14	0.6	2	1.5	9.0	35.7	7.1×10^{-10}	510.6	390
6	0.4	2.5	1.25	5.5	17.6	10.5×10^{-10}	695.7	290
13	0.6	2	0.5	3.5	9.6	11.9×10^{-10}	243.1	260
12	1	2	1	5.8	19.2	10.4×10^{-10}	270.8	300
9	0.6	1	1	4.2	12.4	11.2×10^{-10}	228.2	270
15	0.6	2	1	7.5	25.6	8.8×10^{-10}	362.7	350

The second-order polynomial model was fitted to the experimental data for each response and tested for adequacy and fitness by analysis of variance (ANOVA). Numerical optimization technique of RSM was used to determine the optimum process parameters using Design Expert software. The main criteria for optimization were higher mechanical and barrier properties of films. The optimum blend composition obtained from the predictive model was: 0.85% nanocellulose, 1.59% glycerol and 1.5% PVA. The predicted responses in terms of tensile strength, elongation, water vapour permeability, bursting strength and tearing strength were 9.4 MPa, 38 %, 7.7×10^{-10} g/m.s.Pa, 695 kPa, 354 mN respectively at maximum desirability of 0.94. The predicted values registered non-significant ($p > 0.05$) difference from experimental values at selected optimum conditions (ANOVA not shown). The

model F-value indicated high significance ($p < 0.05$) of the obtained model. In addition, non-significant lack of fit, R^2 and adequate precision depicted fair suitability of model in predicting mechanical and barrier properties of starch based films at varying incorporation of glycerol, nanocellulose and PVA. The films prepared using the optimum blend composition showed significant ($p < 0.05$) improvement in mechanical and water vapour barrier properties.

As developed films have good fat resistant properties, they are being explored for edible oil storage at ambient temp and RH. The storage studies on the effect of packaging films on oxidative rancidity, viscosity and colour properties of refined sunflower oil are underway (Fig. 2).

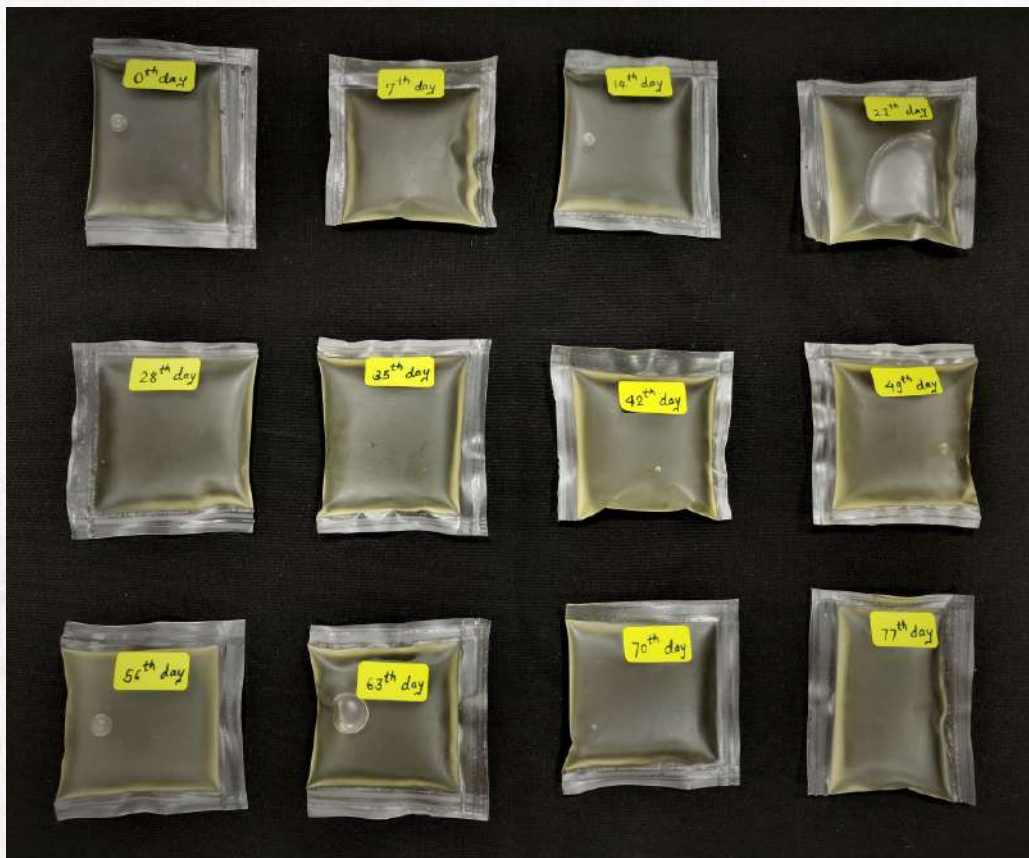

Figure 2: Storage study of refined sunflower oil packed in nanocellulose reinforced starch based biodegradable films

3. TECHNOLOGY MANAGEMENT

ICAR-CIRCOT carries out basic & strategic research in processing of cotton and its agro residues, development of value added products and quality assessment. The research work results in development of machinery, products and process protocols. The Institute is also engaged in the refinement of the already developed technologies in the areas of post-harvest processing of cotton, eco-friendly finishing of textiles and value addition of cotton stalks. Technologies developed are protected through management of intellectual property rights. Assessment, popularization and commercial adoption of viable technologies are carried out regularly through demonstrations, industrial trials, awareness meets, exhibitions and seminars. Impact assessment of already commercialized technologies is also taken up for further improvement.

3.1 Intellectual Property Management

Institute Technology Management Unit (ITMU) takes care of the protection of intellectual property rights of the technologies developed in the Institute and evaluation of commercial

values of different consultancy projects and also the licensing of technology.

During this period eight consultancy projects has been evaluated and processed through Institute Technology Management Unit (ITMU) meetings and Institute Technology Management Committee (ITMC) meeting.

Two major consultancy projects has been sanctioned by M/s. Bank Note Paper Mill India Pvt. Ltd., Paper Mill Compound, Mysuru. Project 1: Development of biocide formulation for cotton based pulp and paper Biocide/Ozone for control of bacterial growth- Ani-microbial Paper and Project 2: Improving the Bleaching Efficiency in Cotton Comber Noil Pulping Process after due evaluation of ITMU committee.

A technology commercialization proposal titled “Nano-ZnO Production Technology” to be transferred to M/s. Rashtriya Chemicals & Fertilizers Limited (RCF), Mumbai was evaluated by the ITMU committee.

Consultancy Project No.	Title of the Project	Name of the Organization to which consultancy offered
CP 1/19-20	Thermal & Comfort Analysis of Silk Samples	Central Silk Technological Research Institute, Central Silk Board, Bengaluru.
CP 2/19-20	Cleaning and Bleaching of Linters	M/s. Atul Limited, Valsad, Gujarat.
CP 3/19-20	Particle Board from Debarked Cotton Stalk	M/s. Dwail Private Limited, Sandbox Startups, Dharwad.
CP 4/19-20	Surface Morphological Characteristic of treated fabric samples by SEM	M/s. TUV SUD South Asia Pvt. Ltd.
CP 5/19-20	Lint Free Data for surgical gowns	M/s. Indoco Remedies Limited, Verna, Goa
CP 6/19-20	Development of biocide formulation for cotton based pulp and paper	M/s. Bank Note Paper Mill India Pvt. Ltd., Paper Mill Compound, Mysuru.
CP 7/19-20	Improving the Bleaching Efficiency in Cotton Comber Noil Pulping Process	M/s. Bank Note Paper Mill India Pvt. Ltd., Paper Mill Compound, Mysuru.
CP 8/19-20	Commercialization of - Nano -ZnO Production Technology	M/s. Rashtriya Chemicals & Fertilizers Limited, Mumbai.

3.2 Technology Incubation:

Agri-Business Incubation (ABI) Centre

ICAR-CIRCOT has established an Agri-Business Incubation (ABI) Centre under 12th Plan Scheme of National Agriculture Innovation Fund (NAIF) (Component II) –Incubation Fund for the benefit of prospective entrepreneurs who wish to start their business using Institute technologies on post-harvest processing of cotton and value addition to its by-products. This centre promotes incubation and business development in cotton and its by-products, conducts techno-entrepreneurial activities in cotton value chain for building prospective clientele and facilitates skill development in

selected stakeholders related to cotton sector. The Agri-Business Incubation (ABI) Centre was launched at ICAR-CIRCOT, Mumbai on 5th February 2016. Since inception, 16 incubates were admitted and 4 incubatees graduated. Three new entrepreneurs were admitted at ICAR-CIRCOT-ABI Centre for incubation on different technologies during the year 2019-20. Five specialized training programme were conducted during the year 2019-20 by ICAR-CIRCOT-ABI Centre. The fourth Advisory committee meeting of ICAR-CIRCOT-ABI Centre was held on 27th August, 2019.



4th Advisory Committee Meeting at ICAR-CIRCOT, Mumbai on 27th August, 2019



Specialized training programme on Advances in Applications of Nanotechnology

Sl. No.	Incubatee	Technology
1	M/s. Plantbase Ventuers Pvt. Ltd., Mumbai	Development of starch based film
2	Entrepreneurship Development Centre, Pune & Fumalabs Pvt. Ltd., Gwalior	Mechanical Property Testing of Paddy straw particle boards and use facilities of ICAR-CIRCOT-ABI Centre for conducting 1 tonne material/day trail at GTC, Nagpur
3	M/s. Kothari Distributors, Hyderabad	Preparation of bio-degradable products using agro biomass (banana, rice straw, bagasse)



Bio-degradable products using agrobiomass by M/s. Kothari Distributors

Sl. No.	Incubatee Graduated	Technology
1	M/s. Kotak Commodities, Mumbai; Mr. Deepak & Mrs. Nettra D. Sorap	Preparation of Value Added Products using Naturally Coloured Cotton
2	M/s. Greyy, Navi Mumbai	“Development of clothing using cotton blend”



Preparation of Value Added Products using Naturally Coloured Cotton



Naturally Coloured Cotton Products



Development of clothing using cotton blend

3.3 Awareness Meets and Demonstrations

❖ An Awareness – cum - Demonstration programme for the preparation of bio-enriched compost from cotton plant residues was organised at the field of Shri Rajaram, village Shahpur Begu in Sirsa District of Haryana State on 17th January, 2019. Ten selected farmers who were to prepare compost in their fields were given hands-on training and live demonstration. Dr. Hamid Hasan explained the

methodology of compost preparation, its nutritional aspects and its beneficial impact on soil health improvement. All the farmers have shown very keen interest in demonstration and have decided to prepare compost in their respective fields. Shri Rajaram, a progressive farmer and secretary of Kisan Club, Sirsa who has been preparing and using this compost for the 4 last years also shared his experiences with farmers.



- ❖ An expert team consisting of Dr. S. K. Shukla and Dr. S. V. Ghadge from GTC, ICAR-CIRCOT, Nagpur, Dr. A. R. Raju, Principal Scientist, ICAR-CICR, Nagpur and Shri. G. H. Wairale, President Agro Plus Foundation visited Amgaon Village, Selu taluk, Wardha Dist., on 4th February 2019. Thirty six farmers from the village participated in the program. Dr. A. R. Raju discussed about the best management practices to be followed in cotton cultivation to realise higher productivity and income. Dr. S. K. Shukla informed to the farmers about clean cotton picking and suggested measures to avoid contamination in cotton.



- ❖ As a part of ICAR initiative on doubling the farmer's income through increasing productivity and adoption of recent farm technologies, Ginning Training Centre, ICAR-CIRCOT, Nagpur organized a *Technology and Machinery Demonstration Mela- 2019 on February 15, 2019*. In this programme, more than one hundred cotton growing farmers from Wardha and Nagpur and stakeholders from industries and research organizations

participated. The program was meant to demonstrate recent technology and machinery on **Cotton Processing and By-Products Utilization** for doubling the farm income.

- ❖ Awareness programme under Mera Gaon Mera Gaurav (MGMG) on 25th May 2019 was conducted at Village Belghat Dist- Wardha. Twenty one farmers attended the programme
- ❖ Dr. S.K. Shukla, Officer In-charge and Principal Scientist and Dr. S.V. Ghadge, Principal Scientist, participated in the farmers meet organized at Wardha, Maharashtra on 17 September 2019. There were 300 farmers representing mostly from MGMT villages were participated in the event. The farmers meet was jointly organized by CITI-CRDA and Bayers crop science
- ❖ Awareness programme on Cotton by product utilization was conducted at Village Warora Dist- Chandrapur on 5th October, 2019. Around 350 farmers attended the programme.
- ❖ Awareness programme and field visits conducted on December 20, 2019 at Village Rehaki, Wardha District



- ❖ Awareness programme and field visits conducted on December 27, 2019 at Village Anji, Wardha District.



- ❖ Awareness programme and field visits conducted on December 31, 2019 at APMC, Hinganghat, Wardha District. Around 200 farmers attended the programme.



3.4 Exhibitions and Agri-Fair

- ❖ An exhibition was arranged to display the technology and machinery on cotton processing and by-products utilization for the farmers during the Technology and Machinery Demonstration Mela at GTC, Nagpur on February 15, 2019. Live demonstration on chipping of cotton stalks, preparation of bio-enriched compost, oyster mushroom cultivation and preparation of pellets were conducted for the benefit of farmers.
- ❖ ICAR-CIRCOT displayed technologies during an exhibition arranged on occasion of 91st Foundation Day celebrations of ICAR at the National Agricultural Science Centre Complex, New Delhi on 16th July, 2019. Hon'ble Shri Narendra Singh Tomar, Union Minister of Agriculture and Farmers Welfare and other dignitaries visited the stall.

- ❖ ICAR-CIRCOT's Ginning Training Centre at Nagpur participated and exhibited ICAR-CIRCOT Technologies & Products in Agrovision-2019 at Nagpur during 22-25 November, 2019. Around 5000 visitors visited CIRCOT stall.

3.5 Radio Talk

- ❖ A phone-in interview of Dr. P. S. Deshmukh on " Maintenance and Repair of Farm Impelements " (Krushi Yantracnhee Dekhbhaal va Durusti) was broadcasted by All India Radio, Mumbai Centre, on AIR Marathi Channel - Asmita Vahini(MW 537.6 m 558KHZ) on 16 April, 2019 at 7.30 PM. Listeners had asked questions related to the topic and were answered directly.

3.6 Television Talks

- ❖ A television interview of Dr. P. G. Patil, Director, ICAR-CIRCOT, on "Cultivation of Colour Cotton and Value added Products from it" (रंगीत कापूस शेती व त्यापासून मुल्यवर्धीत उत्पादने) was telecasted by Doordarshan Kendra Mumbai in Amchi Mati Amchi Manse (आमची माती आमची माणसं) programme of Doordarshan Sahyadri on 16th April, 2019 at 6.30 PM and re-telecasted on 24th and 25th September 2019.



Dr. V. G. Arude, Senior Scientist delivered a TV talk on DD Sahyadri on the topic 'Biomass based ICAR-CIRCOT Green Crematorium' (सिरकाॅटची कृषी अवशेष आधारित पर्यावरणपूरक शवदाहिनी), which was telecasted on Doordarshan Sahyadri on 3rd and 4th September 2019.

4. SKILL DEVELOPMENT AND CAPACITY BUILDING

Skill development and capacity building are very important for every organisation to maintain the quality of the work with the dedicated involvement of the employees. The skill of the work force needs to be upgraded in their respective fields with latest developments so as to enable them to provide maximum output for the organization.

Skill development in the area of post-harvest processing of cotton and value addition to its biomass is one of the mandate of the Institute. Training programmes are organised by the institute for the stakeholders including farmers, ginners, personnel from cotton trade and industry throughout the year. These trainings covers diverse areas of cotton processing.

4.1 Capacity building of Staff

Institute staff are trained as per the training needs assessment plan for the year 2018-2019, to keep pace with the latest technological advancements in the relevant fields. The employees were trained in premier institutions to learn the cutting-edge technologies, and project management methodologies. Impact assessment of the training programme are also carried out after a period of one year to analyse the outcome. The percent realization of trainings planned during the financial year 2018-19 was 129%. Scientists underwent training in diversified fields like advances in

Ginning Training Centre (GTC) of the Institute at Nagpur regularly conducts training for the farmers covering production and post-harvest processing of cotton and utilisation of cotton biomass for value added products. Training courses for Gin fitters and other workers in the ginning industry on technologies for production of clean quality cotton, maintenance of various ginning and allied machines are also organized regularly by GTC.

The institute also organises specialised training programmes on spinning, quality evaluation, material characterisation, nanotechnology, microscopy, electrospinning, absorbent cotton technology, value addition to cottonseeds etc. for the personnel from the academia, industry and entrepreneurs.

microscopy, NABL training and value addition to cottonseed. Technical staff underwent training in the area of skill & personality development, motivation, positive thinking, communication skill, and automobile maintenance. Administrative staff were trained in official language management, behavioural skills, pay fixation and NPS management. Supporting staff underwent training on skill development. For the current year (2019-20), all the staff are enthusiastically participating in the various training programmes as per the designed annual training plan.

Table 4.1 Skill development of Institute Staff

Programme Title	Duration	Venue	Name(s)
Scientific Staff			
Advances in Microscopy	January 17-19, 2019	ICAR-CIRCOT, Mumbai	Er. Jyoti Dhakane - Lad
Extraction and Isolation of Phytoconstituent	February 09-10, 2019	ICT, Mumbai	Dr. Santanu Basak
ISO/IEC 17025: 2017 training program,	Mar 05-08, 2019	ICAR-CIRCOT, Mumbai	Dr. Sujata Saxena Dr. P. S. Deshmukh Dr. G. Krishna Prasad
Block chain Technology	May 11-12, 2019	Andheri (East), Mumbai	Dr. C. Sundaramoorthy
Executive Development Programme on Developing Effective Organisational Leadership for Senior Officers of ICAR (National component)	August 2-4, 2019	ASCI, Hyderabad	Dr. P. G. Patil
Executive Development Programme on Developing Effective Organisational Leadership for Senior Officers of ICAR (Foreign component)	September 21-28, 2019	Netherlands, Switzerland, Germany and Belgium	Dr. P. G. Patil
Refresher course in Chemical Engineering	October 4, 2019	Institute of Chemical Technology (ICT), Mumbai	Dr. Sujata Saxena
Technical Staff			
Automobile Maintenance, Road Safety and Behavioural Skills	February 19-25, 2019	ICAR-CIAE, Bhopal	Shri Santosh V. Kokane
KOHA for Library Staff of ICAR	February 21-26, 2019	ICAR-NAARM, Hyderabad	Smt. Medha P Kamble
ISO/IEC 17025: 2017 training program,	Mar 05-08, 2019	ICAR-CIRCOT, Mumbai	Shri Nishant D. Kambli Shri R. R. Chhagani Dr. Sujata Kawlekar Shri R. S. Narkar Dr. N. M. Ashtaputre Shri Manoj Ambare Dr. C. D'souza Shri S. Banerjee Shri B. R. Pawar Shri C. M. More

Programme Title	Duration	Venue	Name(s)
-----------------	----------	-------	---------

Technical Staff

ISO/IEC 17025: 2017 training program,			Shri H. S. Koli Shri V. D. Kalsekar Shri Prashant Gavhale Shri Paresh Thakur Shri R. K. Jadhav Shri Krishna Bara Smt. P. S. Nirhali
Motivation, Positive Thinking and Communication Skills for Technical Officers (T-5 and above) of ICAR Institutes (Off-campus ICAR-NAARM)	March 13-19, 2019	ICAR-IISWC, Dehradun	Shri B. R. Pawar Smt. Prachi R Mhatre Dr.Hamid Hassan

Administrative Staff

TA & LTC Rules	March 07-08, 2019	Institute of Govt. Accounts and Finance, Mumbai	Shri Avinash Aman
Pay Fixation & MACP	March 11-12, 2019	Institute of Govt. Accounts and Finance, Mumbai	Shri Avinash Aman Shri Sainath N Sahane
Pension and other retirement benefits	August 13-14, 2019	Training Centre of Mumbai	Sh. S. V. Kasabe Sh. S. Angane Sh. S. Shahane
Functions of Drawing and Disbursement officer	August 6-9, 2019	Training Centre of Mumbai	Sh. R. K. Pallewad
Income Tax on Salaries	October 17-18, 2019	Training Centre of Mumbai	Smt. S. G. Parab
Training on Medical Rules Schedule (CGHS/CSMA)	November 6, 2019	Training Centre of Mumbai	Mrs. Bharati Kherodkar Mrs. Jayashree Chavkute Mr. Tushar Dhamange Miss Himani Singh
Leave rules and maintenance of Service book	November 14-15, 2019	Training Centre of Mumbai	Mrs. Trupti Mokal Ms. Pooja Tiwari Mr. Satish Aangane
Annual Performance Appraisal Report	December 16, 2019	Training Centre, Mumbai	Mr. Avinash Aman

Programme Title	Duration	Venue	Name(s)
Administrative Staff			
Training programme on “Public Procurement”	December 16-20, 2019	Institute of Financial Management, Faridabad	Ms. Pooja Tiwari

Skilled Support staff

Training on Skill Development for Supporting Staff	March 12, 2019	ICAR-CIRCOT, Mumbai	Shri V. B. Pujari Shri S. K. Bhobate Shri S. R. Tondse Shri D. K. Kasar Shri M. Z. Rathi Shri G. O. Thapa
--	----------------	---------------------	--

4.2 Trainings organised to stakeholders

The Institute has been conducting regular training programmes for students, farmers, entrepreneurs and personnel employed in cotton and ginning sectors. Training programmes related to advances in cotton technology in the field of chemical processing, nano-technology, spinning, quality evaluation

and use of advanced instrumentation are conducted at Mumbai headquarters. At Ginning Training Centre, Nagpur, training programmes on Ginning technology, Post-harvest processing & value addition to cotton by-products and Quality evaluation and grading of cotton are organised.

Table 4.2 Training Programmes organised during 2019**International**

Programme Title	Duration	No. of Participants	Participants' Profile
Bohicon, Benin			
Operation, Maintenance and Management of ‘Modern Double Roller Ginning Plant under Cotton TAP	September 23-27, 2019	10	Industry

National

Programme Title	Duration	No. of Participants	Participants' Profile
-----------------	----------	---------------------	-----------------------

ICAR-CIRCOT, Mumbai

Advances in Microscopy	January 17-19, 2019	06	ICAR, Academics
Fibre Reinforced Composites	February 04-06, 2019	05	ICAR, Academics, Students
Quality Evaluation of Cotton	May 27-31, 2019	04	Traders, Industry
Quality Evaluation of Cotton	July 29- August 02, 2019	10	Traders, Industry
Absorbent Cotton Technology	September 19-21, 2019	10	Industry
Advance in Applications of Nanotechnology	September 23-27, 2019	21	ICAR, Academics, Industry, Students
Basics of Knitting and Knit Garments	December 11-13	13	Academics, Students

GTC of ICAR-CIRCOT, Nagpur

Increasing Farm Income through Increase in Production and Processing of Cotton at Village Level	January 08-11, 2019	30	Farmers
Increasing Farm Income through Increase in Production and Processing of Cotton at Village Level	January 22-25, 2019	30	Farmers
Increasing Farm Income through Increase in Production and Processing of Cotton at Village Level	February 04-07, 2019	30	Farmers
Increasing Farm Income through Increase in Production and Processing of Cotton at Village Level	February 25-28, 2019	30	Farmers
Double Roller Ginning Technology & Basics of Cotton Quality Evaluation	April 22-27, 2019	06	Industry
Training course for Operators, Supervisors and Managers of Modern Saw Ginning Plant	May 16-31, 2019	26	Industry

GTC of ICAR-CIRCOT, Nagpur

Programme Title	Duration	No. of Participants	Participants' Profile
Cotton Production and Post-harvest Processing	May 20-23, 2019	30	Farmers
Operation, Supervision and Management of Modern Rotobar Ginning Plants	July 29 – August 10, 2019	20	Industry
Cotton Production and Post-harvest Processing	August 06-09, 2019	26	Farmers
Double Roller Ginning Technology and Basics of Cotton Grading	August 16-21, 2019	09	Industry
Cotton Production and Post-harvest Processing	August 21-24, 2019	25	Farmers
Cotton Production and Post-harvest Processing	September 16-19, 2019	35	Farmers
Cotton Production and Post-harvest Processing	September 23-26, 2019	31	Farmers
Cotton Production and Post-harvest Processing	December 09-12, 2019	22	Farmers

Total number of training programmes	Number of beneficiaries	Revenue generated (Rs. Lakhs)
22	426	23.47

4.3 Education

The University of Mumbai has accorded permanent recognition to ICAR-CIRCOT for guiding students leading to **M.Sc.** (by research)

in subjects: Physics, Bio-physics, Microbiology and Organic Chemistry and **Ph.D.** in Physics and Microbiology.

Ph.D. Students on roll

Name of Students (Research Guide)	Year of Admission	Research Topic	Status
Mrs. Sangeeta M. Chavan (Dr. N. Vigneshwaran)	2012	Effect of silver, zinc oxide and titania nanoparticles on nitrogen fixing, phosphate solubilizing and biofilm forming bacteria found in soil ecosystems.	On-going
Ms. Komal Saraf (Dr. N. Vigneshwaran)	2012	Preparation of nanofibre mats of alginate and pullulan by electro spinning and its application as nanosensor for detection of food spoilage	On-going
Ms. Siddhi Juikar (Dr. N. Vigneshwaran)	2012	Microbial production and Characterization of Nano-Lignin and its application onto cotton and linen fabrics for functional properties	Degree Awarded on 20 th February 2019
Ms. Priyanka Bagde (Dr. N. Vigneshwaran)	2014	Immobilization of antimicrobial peptides on nanocellulose for potential use in active food packaging	Thesis submitted

ICAR-CIRCOT has signed MoUs with educational institutions to promote research and teaching in the sphere of cotton science and technology. The MoU helps in carrying out joint research work & creates an opportunity for pursuing post graduate & Doctoral degree programmes. ICAR-CIRCOT has signed MoU with following educational institutions.

1. VJTI, Mumbai.
2. Dr. BSKKV, Dapoli.
3. UAS, Dharwad
4. SNTD, Mumbai
5. ICT, Mumbai

In addition, to promote the quality post graduate research and training in cutting edge areas, ICAR-CIRCOT facilitate students from NARS and other organizations to access specialized guidance and facilities as per the ICAR's **Guidelines for the students to conduct research for their degree programmes as trainees at ICAR institutions.**

4.4 HRD Achievements

HRD Targets & Achievements for Apr 2018 to Mar 2019

<i>Category</i>	<i>Total No. of Employees</i>	<i>No. of trainings planned for each category during 2018-19 as per ATP</i>	<i>No. of employees undergone training during April 2018 to March 2019</i>	<i>% realization of trainings planned during 2018-19</i>
Scientist	28	7	6	85.71
Technical	68	10	29	290.00
Administrative & Finance	33	9	8	88.89
SSS	40	12	6	50.00
Total	169	38	49	128.95

HRD Targets & Achievements for Apr 2019 to Dec 2019

<i>Category</i>	<i>Total No. of Employees</i>	<i>No. of trainings planned for each category during 2019-20 as per ATP</i>	<i>No. of employees undergone training during April-Dec 2019</i>	<i>% realization of trainings during 2019-20</i>
Scientist	26	10	2	20
Technical	64	7	0	0
Administrative & Finance	32	6	7	116
SSS	36	6	0	0.00
Total	158	29	9	31.03



Training on Skill Development for Supporting Staff organized on 12th March 2019 at ICAR-CIRCOT, Mumbai



Interaction of Microscopy trainees of ICAR-CIRCOT with DG, ICAR during January 17-19, 2019 at ICAR-CIRCOT, Mumbai.

5. Linkages and Collaboration

Maintaining linkages with various organizations at national and international level in the domain of research, education, skill development and extension is a very important policy of ICAR-CIRCOT. Linkages with stakeholders helps to foster research, enhance technology assessment and refinement, capacity building and eases the transfer of technology from lab to the land.

ICAR-CIRCOT is a technology partner for the AICRP on Cotton and Principal investigator of Quality Research. The institute is linked to ICAR institutions and State Agricultural University involved in the cotton breeding programmes. The institute is also a part of the Central Variety Release Committee and the cotton varieties release should fulfil the CIRCOT quality norms.

The Institute has taken a new initiative to include the industrial stakeholders at the project initiation stage. This has led to development of linkage with industrial stakeholders through signing of Memorandum of Understanding (MoU) for carrying out collaborative research and machinery development in public private partnership mode. The association with the institutional stakeholders like Cotton Corporation of India (CCI) has also been strengthened to work in participatory mode for technology development.

The Institute is the nodal centre for implementation of the Consortia Research Platform (CRP) on Natural Fibres. Under this project the linkage has been established with institutes working in the field of natural fibres such as ICAR-NINFET, Kolkata, Assam Agricultural University, Jorhat and TNAU, Coimbatore.

The institute has Regional Quality Evaluation (QE) units located within the premises of other institutes and agricultural universities in the country. The main functioning of these units is as extension wings of the Institute. In addition to this, these units also facilitate linkages and collaboration with the host institutes.

Agri-Business Incubation (ABI) Centre of the Institute works towards promotion of entrepreneurship based on institute technologies and has created linkage with budding entrepreneurs, industries and other institutions working towards transformation of innovative ideas into new enterprises.

International collaboration with the stakeholders of the cotton sector in the African Countries was also created by the Institute. A partnership has been established with the United National Conference on Trade and Development (UNCTAD), Geneva for promoting cotton by-products in Eastern and Southern Africa especially in Zambia, Zimbabwe, Tanzania and Uganda. The different organizations and key stakeholders from the countries of Zambia, Zimbabwe and Uganda were invited for a study visit to learn from India's experience under the aegis of UNCTAD. In the process the linkage was also established with International Trade Centre (ITC) and COMESA.

Memoranda of understanding (MoUs) were signed for development / commercialization of Institute technologies for cotton processing and value addition to by-products with different institutions, industries and individuals.

5.1 MoU Signed

Research Collaboration

1. MoU was signed with Cotton Corporation of India (CCI) for "Technical knowhow and advice as Consultants to develop affordable machines for testing of cotton at farm level and to transfer technical knowledge with regard to best practices to Indian farmers" on January 25, 2019
2. Memorandum of Understanding (MoU) was signed with ICAR-CICR, Nagpur and Dr. P.D.K.V., Akola for Promotion of Naturally Coloured Cotton Production and Value Addition" on July 25, 2019.

Technology Incubation

3. Memorandum of Understanding (MoU) signed with Shree Agro Invent-tech Pvt. Ltd., for "Conceptualization, Design and development of technically Advanced Textile Materials and Conversion to related Products" on September 05, 2019.
4. MoU was signed with M/s. Kothari Distributors, Hyderabad (Incubatee) for "Incubation on preparation of bio-degradable products using agro biomass (banana, rice straw, bagasse) on January 03, 2019.
5. MoU Signed with M/s. Plantebase Ventures Pvt. Ltd., Mumbai for "Development of starch based film for packaging" on February 26, 2019

Technology Commercialization

6. MoUs was signed between ICAR-CIRCOT and AIC-NIFT TEA Incubation Centre for

Textiles and Apparels, Tirupur for promotion of intensive innovation and startups in the textiles salt free dyeing technology, eco-friendly processing of textiles, new product development using cotton and other natural fibres on March 15, 2019

7. Non- disclosure agreement (NDA) to explore the possibility of industrial adoption of salt free dyeing technology of cellulosic textiles and studying its effect on effluent treatment especially zero liquid discharge was signed with M/s. SRG Apparels Ltd, Tiruppur on June 10, 2019.
8. Memorandum of Understanding (MoU) was signed with M/s Rashtriya Chemicals and Fertilizers Ltd. (RCF), Mumbai to commercialize the ICAR-CIRCOT nano-ZnO production technology and to develop Nano-formulation for Fertilizer Applications on September 04, 2019.
9. Memorandum of Understanding (MoU) was signed with M/s. Precision Tooling Engineers, Nagpur for "Manufacturing Miniature Ginning Machines" on November 18, 2019.
10. Memorandum of Understanding (MoU) was signed with M/s. Vidarbha Sales, MIDC, Hingna, Wardha Road, Nagpur-440012 for Continuous Feeding Pellet Stove (CFPS) with pellets as fuel (partially cotton stalk pellets) on November 27, 2019.

5.2 Commercial Testing Services

CIRCOT is one among acclaimed NABL accredited cotton testing laboratories in India. The Institute has facilities for conducting more than 178 tests on different textile materials and cotton by-products. These facilities are

extended to various stakeholders. Besides regular tests, special tests were also carried out as per demand on samples received from various government/ private organisations and universities.

During the year 2019, a total number of 19218 samples were tested at different test centres including headquarters at Mumbai, GTC Nagpur and quality evaluation units at Coimbatore, Dharwad, Guntur, Sirsa and Surat. Total revenue generated through commercial testing during the year 2019 was ₹ 97,880,36/-.

The Institute maintains liaison with different institutions including private organizations and entrepreneurs and strives to meet their technological needs by offering various other need based services and generates additional revenue through the activity.

TABLE 5.1 NUMBER OF PAID SAMPLES TESTED AND REVENUE GENERATED

Test Centre	No. of Samples Tested	Revenue Generated (Rs)
Mumbai	6214	5404501.90
Nagpur	6996	3058624.40
Coimbatore	5501	1037744.00
Dharwad	84	15694.00
Guntur	229	34663.00
Sirsa	172	227487.00
Surat	22	9322.00
Total	19218	9788036.30

TABLE 5.2 TESTS CONDUCTED AND CLIENTELE

Test	Party Name
Absorbent Cotton test	❖ Medicon Surgicals, Nagpur
ASH	❖ Umesh Board & Paper Mills Pvt Ltd., Aurangabad
BET	❖ SPPSPTM, Vale Parle West ❖ Institute of Chemical Technology, Mumbai ❖ Director, Central Institute of Fisheries Education, Mumbai ❖ VJTI, Matunga, Mumbai.
Biodegradation	❖ Kusum Baser, Sanpada, Navi Mumbai
Cellulose yield	❖ Cottor Plants India Pvt. Ltd., Mumbai.
Contact angle	❖ ICAR-NINFET, Kolkata
Degree of Polymerisation	❖ L. N. Oils, Dharwad ❖ Jalaram Ginning Factory, Ahmedabad ❖ Aditya Birla Science & Technology Co. Pvt. Ltd., Mumbai
FTIR	❖ Director, Central Institute of Fisheries Education, Mumbai ❖ ICAR-CIFT, Vashi ❖ VJTI, Matunga, Mumbai.

Test	Party Name
Gossypol	❖ Chhattisgarh State Co-op. Marketing Federation Ltd., Durg, Chhattisgarh
Paper GSM testing	❖ Patel Paper Company , Pune ❖ Shivaji Vidyapeeth, Kolhapur
Instron	❖ Godavari Bio-refineries Ltd., Mumbai ❖ VJTI, Matunga, Mumbai ❖ JDIET , Yavatmal ❖ Institute of Chemical Technology, Mumbai
LigninContent	❖ Raymond Luxury Cottons Ltd., Kolhapur
Linter testing	❖ Security Paper Mill, Hoshangabad
Lyophilisation	❖ G. N.Khalsa College, Matunga, Mumbai. ❖ V. G.Vaze College, Mulund, Mumbai. ❖ Apollo College of Pharmacy, Durg
Oil content	❖ Rites Limited, Mumbai
Particle size	❖ ICARCIFT, Vashi ❖ Indian Institute of Pulses Research, Kanpur
SEM	❖ Director, Central Institute of Fisheries Education, Mumbai. ❖ C. K. T. College, Panvel ❖ Gangwal Chemicals Pvt. Ltd., Boisar ❖ Institute of Chemical Technology, Matunga. ❖ SPPSPTM, Vale Parle West, Mumbai. ❖ Watson Pharma Pvt. Ltd., Mumbai. ❖ Vignan's Lara Institute of Technology & Science ❖ VJTI, Matunga ❖ DMAPR, Boriavi, Anand, Gujarat ❖ Indoco Remedies Ltd., Rabale, Mumbai. ❖ Oriental Aromatics Ltd. Andheri ❖ Reliance Industries Ltd., Mumbai ❖ CIFT, Vashi, Navi Mumbai. ❖ Rubicon Research Pvt. Ltd., Thane. ❖ C. U. Shah College of Pharmacy, Mumbai. ❖ Indian Institute of Pulses Research, Kanpur ❖ NMIMS, Vile Parle West, Mumbai. ❖ Ruparel College, Mumbai ❖ Bombay College of Pharmacy, Mumbai ❖ ICARNINFET, Kolkata ❖ Nirma University, Ahmedabad ❖ TUV SUD ,Mumbai ❖ IQ Gen X Pharma Pvt. Ltd., Navi Mumbai

Test	Party Name
Sulphated Ash	❖ Medicon Surgicals, Nagpur ❖ NH Healthcare, Hyderabad
Tensile strength	❖ Umesh Board & Paper Mills Pvt. Ltd., Aurangabad ❖ Medi Heal Solutions
Tear Strength	❖ Umesh Board & Paper Mills Pvt. Ltd., Aurangabad
Total bacterial & Fungal count	❖ Ecosense Labs (I) Pvt. Ltd., Mumbai.
UPF	❖ Yamini Dhanania, Kolkata ❖ MGIRI, Wardha ❖ B K Birla College of Art, Science & Commerce, Kalyan

Linkages with Institutions



6. AWARDS AND RECOGNITION

12th Doordarshan Sahyadri Krishi Sanman Award- 2019

Doordarshan Sahyadri Krishi Sanman Award 2019 in the category of **Research in Agriculture / Meritorious work in Innovative Field** was conferred to team of scientists from ICAR-CIRCOT for their remarkable research work in by-product utilization of cotton. The award was given by Honorable Dr. Anil Bonde, Minister of Agriculture, Government of Maharashtra on 3rd July 2019 at Mumbai.

A team comprising of Dr. P. G. Patil, Director of the institute and Dr. S. K. Shukla, Dr. V. G. Arude, Dr. V. Mageshwaran, Dr. C. Sundaramoorthy, Dr. P. S. Deshmukh, Dr. A. K. Bharimalla realised the importance and economic potential of value

addition to cotton stalk and developed commercially viable and eco-friendly technologies and products viz. briquettes, pellets, charcoal, activated carbon, particle boards, briquette based eco-friendly green crematorium, efficient pellet stove, compost and mushroom cultivation. These Technologies are useful for doubling cotton farmer's income. These technologies not only generated renewable energy but also improved soil health and created rural entrepreneurship. This research work helped in creating business opportunities in establishing cotton by-product based industries in Vidarbha.



ICRA-ASIA Young Scientist Innovation Medal - 2019

Dr. N. Vigneshwaran, Principal Scientist from ICAR-Central Institute for Research on Cotton Technology, Mumbai has been selected for the International Cotton Researchers Association (ICRA) – ASIA Young Scientist Innovation Medal - 2019 and the same was conferred during the 8th meeting of the Asian Cotton and

Development Network, in Tashkent, Uzbekistan during September 9-12, 2019. This award, setup by ICRA, International Cotton Advisory Committee (ICAC), Washington DC, USA, recognizes the young cotton researchers from Asian countries. Dr. Vigneshwaran's research group at ICAR-CIRCOT is working in field of

nanotechnology application in cotton textiles, pulp & paper technology and composites towards the development of novel and value added products under the dynamic leadership of Dr. P. G. Patil, Director ICAR-CIRCOT, Mumbai.

The state-of-the-Art Nanotechnology facility at ICAR-CIRCOT caters to the need of cutting edge research, specialized trainings, incubation & entrepreneurship development. Dr. P. G. Patil felicitated Dr. N. Vigneshwaran on this occasion.

Avishkar Research Convention Award

ICAR-CIRCOT participated in the 13th Inter-Collegiate / Institute / Department Avishkar Research Convention organized by Department of Students' Development, University of Mumbai for the academic year 2018-19. This convention held on 23rd July 2019 in 'Sir Cowasjee Jehangir Convocation Hall', University of Mumbai, Fort, Mumbai. Based on the research presentation "Microbial production and characterization of Nano-lignin and its application onto cotton and linen fabrics for functional properties", ICAR-CIRCOT has

been awarded an "Overall Championship (First Rank) in Pure Sciences Category" in the Convention. Dr. P. G. Patil, Director, ICAR-CIRCOT received the award at the hands of Prof. Suhas Pednekar, Vice Chancellor, University of Mumbai in the august presence of Prof. S.S. Bhagwat, Dean (IQAC), Institute of Chemical Technology, Mumbai. Dr. N. Vigneshwaran, Principal Scientist & Guide from ICAR-CIRCOT and Dr. Siddhi J Juikar, Student awardee were also present while receiving the award.



Lead / Invited Presentations

Topic	Event / Organizer / Venue	Delivered by
“Opportunities in Natural Fibre Waste Utilization Cotton” (invited lecture)	National Seminar on “Natural Fibre resource Management for Sustainable development” at ICARNINFET, Kolkata during February 02-03, 2019.	Dr. A. S. M. Raja Dr. P. G. Patil
“Future Prospects of cottonseed/cottonseed meal for Food and Feed purposes” (invited paper)	Cottonseed, Oil & Meal Conclave 2019 organised by SEA & AICOSCA on 23 rd and 24 th March 2019 at Hyderabad	Dr. Sujata Saxena
Environment friendly developments in Chemical Processing of Cotton Textiles (invited talk)	National Conference on Recent Advances in Physical Sciences organized by International Academy of Physical Sciences and Kamladevi Rathi College, Rajnandgaon during 18 th -19 th November 2019 at Rajnandgaon (C.G.)	Dr. Sujata Saxena
On farm storage structures: design consideration and operation (Invited Lecture)	Model Training Course on "Entrepreneurship Development through Hi-Tech Agricultural Structures" during 16-23 September, 2019 at Shetkari Sadan, Dr. PDKV, Akola on 19-9-2019	Dr. D. M. Kadam
“Role of Ginning Factories in Pink Bollworm Control” (Invited Lecture)	Sensitization workshop “IRM : Dissemination of Pink Bollworm Management Strategies” organized by ICAR-CICR at Sirsa on November 01, 2019	Dr. Hamid Hasan,

Best Paper Award

Best poster award by The Natural Fibre Society, NINFET, Kolkata to the paper titled "Beater Mechanism for Arecanut (areca catechu L.) Husk Fibre Production" authored by P.S. Deshmukh, P.G. Patil, P. U. Shahare, J. S. Dhekale, G.B. Bhanage, V. G. Arude, A. K. Bharimalla and S.V. Ghadge, presented in National Seminar on Fibre Resource management for Sustainable Development held at ICAR-National Institute of Natural Fibre Engineering and Technology (NINFET) during 2-3 February, 2019.

A paper “Green initiatives of ICAR-CIRCOT Agribusiness Incubation Centre for Empowering Agripreneurs” authored by Bharimalla, A. K., Sundaramoorthy, C., Patil, P. G., Mukerjee, S., and More, M. and presented by Dr. C. Sundaramoorthy in First International Conference on Entrepreneurship in Agriculture and Renewable Energy Sector (EARES-2019) organized at Dr. Punjabrao Deshmukh Krishi Vidyapeeth, Akola during 15-16 March 2019 received **Best Paper award**.

Professional Society / Institution

Dr Dattatreya M Kadam, Principal Scientist joined Editorial Board of International **Journal of BioSciences and Technology (IJBST)**" 2019.

Work in Official Language

Ashirvad Rajbhasha Gourav Puraskar

Ashirvad Rajbhasha Gourav Puraskar for outstanding Hindi implementation activities in the institute for the year 2019 was awarded to

Dr. P. G. Patil, Director at the Ashirvad Awards function held on 20th September, 2019.



Sports

A team of Five winners from the zonal tournament participated in the ICAR inter zonal sports tournament held at ICAR-Indian

Veterinary Research Institute (ICAR-IVRI), Izatnagar, Bareilly from 25-28 February 2019 and won 1 Gold, 3 silver and 1 bronze medals.



Shri R. S. Prabhudesai	Chess	Gold Medal
Smt. Hemangi Pednekar	Chess	Silver Medal
Smt. Jyoti Dhakane Lad	Badminton Singles	Silver Medal
Kum. Nikky Shokeen	Javelin throw	Silver Medal
Kum. Nikky Shokeen	Shotput	Bronze Medal

A team consisting of 14 staff members from ICAR-CIRCOT participated in Zonal Sports Meet at CSWRI, Avikanagar, Rajasthan from 14th -19th

November 2019 and have won 13 medals in various events

Smt. Jyoti Dhakane Lad	Badminton Singles	Gold Medal
Smt. Jyoti Dhakane Lad Miss. Himani Singh	Badminton Doubles	Gold Medal
Smt. Hemangi Pednekar	Chess	Gold Medal
Smt Smita Paiyala	Carom	Gold Medal
Smt. Hemangi Pednekar	Carom	Silver Medal
Smt. Smita Paiyala	Table Tennis Singles	Silver Medal
Smt. Smita Paiyala Smt. Vijaya Walzade	Table Tennis Doubles	Silver Medal
Shri Pradeep V. Jadhav Shri M. M. Kadam Shri R. R. Gosai Shri .D. J.Dhodia Shri. R. S. Prabhudesai	Table Tennis	Silver Medal



7. PUBLICATIONS

7.1 Research papers

- Priyanka, B. and Vigneshwaran, N. (2019) Improving the stability of bacteriocin extracted from *Enterococcus faecium* by immobilization onto cellulose nanocrystals, *Carbohydrate Polymers*, 209, 172-180
- Archana Mahapatra, Sharmila Patil, V. D. Gotmare, P. G. Patil, A. Arputhraj. "Effect of textile softeners on BTCA treated cotton fabric". *Indian Journal of Fibre & Textile Research*, Vol: 45, 96-101
- Manoj Kumar, Anil Dahuja, Archana Sachdev, Charanjit Kaur, Eldho Varghese, Supradip Saha, K. V. S. S. Sairam. (2019). Valorisation of black carrot pomace: microwave assisted extraction of bioactive phytochemicals and antioxidant activity using Box–Behnken design. *Journal of Food Science and Technology*. <https://doi.org/10.1007/s13197-018-03566-9>.
- V. G. Arude, S. P. Deshmukh, P. G. Patil and S. K. Shukla (2018). Application of response surface methodology to optimise single locking cotton feeder for enhancing ginning efficiency of double roller gin. *Indian Journal of Fibre and Textile Research (IJFTR)* (ISSN: 0971-0426), Vol. 44, March 2019, pp. 16-23. *NAAS rating* 6.37.
- S Chavan, N Vigneshwaran Effects of Nanoparticles on Plant Growth-Promoting Bacteria in Indian Agricultural Soil, *Agronomy* 9 (140), 1-18. *NAAS rating* 7.42
- Mageshwaran, V., Satankar, Varsha and Jagajanantha, P. "Optimization of enzymatic process for preparation of absorbent cotton" *Indian Journal of Fibre and Textile Research*, Vol 44, page 223-229.
- Murgesan, M. and Senthilkumar, T. "Study on Hairiness of the yarn produced using cotton and polyester/cotton blended roving with different traveler number and twist level, *Cotton Research Journal*, Vol:8, No:2, Page 58-61.
- Murgesan, M. and Senthilkumar, T. "Study on Quantity of Waste Collected at Ring Frame Drafting System for Different Hanks of cotton and polyester/ Cotton blended roving produced using cotton and polyester/cotton blended roving, *Cotton Research Journal*, Vol:8, No:2, Page 67-70.
- Shukla, S. K., Patil, P. G. and Sundaramoorthy, C. "Mechanical Harvesting of Cotton: a Global Research Scenario and Indian Case Studies" *Cotton Research Journal*, Vol: 8, No: 2, Page 46-57.
- Raja, A. S. M., Arputhraj, A. and Saxena, Sujata "Development of Eco – friendly Low Temperature Bleaching Process for the Production of Absorbent/Bleached Cotton" *Cotton Research Journal*, Vol:8, No:2, Page 62-66
- Sundaramoorthy, C., Patil, P. G. and Mandhyan, P. K. "Contamination Status of Indian Cotton" *Cotton Research Journal*, Vol:8, No:2, Page 79-81
- Deshmukh, P. S., Patil, P. G., Shahare, P. U., Bhanage, G. B., Dhekale, J. S., Dhande, K. G. and Aware, V. V. "Effect of mechanical and chemical treatments of arecanut (areca catechu L.) fruit husk on husk and its fibre" *Waste Management*, Vol 95, 15 July 2019, Pages 458-465
- Bagde, P. and Vigneshwaran, N. "Mechanical, antibacterial and

- biodegradable properties of starch film containing bacteriocin immobilized crystalline nanocellulose”, *Carbohydrate Polymers*, 222, 115021, 2019
14. Krishna Prasad, G., Periyasamy, S., Senthilkumar, T., Raja A. S. M. and Patil, P. G. “A Review on Surface Modification of Textile Substrate Using Plasma to Improve Interfacial Bonding with Rubber Matrix”, *Chemical Science Review and Letters*, 2019, 8(30), 179-184
 15. Shukla A, Sharma V, Basak S and Ali SW, Sodium lignin sulfonate: A bio-macromolecule for making fire retardant cotton fabric, *Cellulose*, 2019; 26(14): 8191-8208
 16. Kumar Manoj, Mageshwaran V., Saxena Sujata, D' Souza Charlene, Ashtaputre Nandita, Patil Sharmila, Mahapatra Archana, Patil, P. G. and Tak, Yamini. (2019). Value addition of cottonseed meal for feed industries by degossypolization employing papain and solvent. *Research Journal of Biotechnology*, Vol. 14 (11): 22-29. (NAAS rating 6.00)
 17. Bollinedi, H., Dhakane-Lad J., Gopala K. S., Bhowmick P. K., Prabhu K. V., Singh N. K., Singh A. K. (2019). Kinetics of β -carotene degradation under different storage conditions in transgenic Golden Rice® lines. *Food Chemistry*, 278: 773-779 <https://doi.org/10.1016/j.foodchem.2018.11.121> (NAAS rating 10.53)
 18. Chattopadhyay, S. K. and Guruprasad, R. Blending of Cotton and Poly lactic Acid (PLA) Fiber: Combined Optimization of Blend Ratio and Yarn Twist Using Mixture-Process Design, *Journal of Natural Fibbers*, DOI: 10.1080/15440478.2019.1642825, 2019, 1-13.
 19. Chattopadhyay, S. K. and Venugopal, Bindu “Effects of Fibre Length Relative to Rotor Diameter on Yarn Tensions During Rotor Spinning and Its Correspondence with Yarn Quality, *Journal of The Institution of Engineers (India): Series E Chemical and Textile Engineering*”, DOI 10.1007/s40034-019-00152-2, 2019, 1-8.
 20. Sharmila Patil, Archana Mahapatra, V. D. Gotmare, P. G. Patil, A. K. Bharimalla and A. Arputharaj. (2019). Effect of different mercerization techniques on tactile comfort of cotton fabric. *Indian Journal of Fibre & Textile Research*. 44: 217-222. (NAAS rating: 6.37)
 21. Basak, S. and Ali, S. W. Wastage pomegranate rind extracts (PRE): a one step green solution for bioactive and naturally dyed cotton substrate with special emphasis on its fire protection efficacy, *Cellulose*, 2019, 26 (5): 3601-3623. [NAAS rating: 9.97]
 22. Basak, S. and Ali, S. W. Sodium tri polyphosphate in combination with pomegranate rind extracts as a novel fire retardant composition for cellulose polymer. *Journal of Thermal Analysis and Calorimetry*, 2019, 1-15 [NAAS rating: 8.5]

7.2 Book Chapters

1. A book chapter published in Woodhead Publications, on the topic, “Cotton-based smart fabric for warm garments” by P. Jagajanantha , G. Maheswaran , P. K. Mandhyan, A. Arputharaj, T. Senthilkumar , G. Krishna Prasad and P. G. Patil (ISBN: 978-93-88320-15-3)
2. N Vigneshwaran, AK Bharimalla, A Arputharaj, PG Patil, Nanocellulose from Agro-Residues and Forest Biomass for Pulp and Paper Product, In: *Nanoscience for Sustainable Agriculture*, (Eds) RN Pudake, N Chauhan, C Kole, Pg. 355-372, 2019.

3. N Vigneshwaran, DM Kadam, S Patil, Nanomaterials for Active and Smart Packaging of Food, In: Nanoscience for Sustainable Agriculture, (Eds) RN Pudake, N Chauhan, C Kole, Pg. 581-600, 2019
4. Samanta K K, Pandit P, Samanta P and Basak S, Water consumption in textile processing and sustainable approaches for its conservation in Water in Textiles and Fashion, Edited by Muthu S, 2019, 41-59, Woodhead Publishing.
5. Laha A, Biswas D and Basak S, Nanotechnology explored for water purification in Advanced research in nanosciences for water technology, Edited by Ram Prasad, T. Karchiyappan, 2019, 180-194, Springer Nature
6. A paper entitled “Green initiatives of ICAR-CIRCOT Agribusiness Incubation Centre for Empowering Agripreneurs” was presented by Dr. Sundaramoorthy, C., in First International Conference on Entrepreneurship in Agriculture and Renewable Energy Sector (EARES-2019) at Dr. Punjabrao Deshmukh Krishi Vidyapeeth, Akola during 15-16 March 2019. The article received the Best Paper Award.
7. An invited paper entitled “Future Prospects of cottonseed/cottonseed meal for Food and Feed purposes” was presented by Dr. Sujata Saxena, in the Cottonseed, Oil & Meal Conclave 2019 organised by SEA & AICOSCA on 23rd and 24th March 2019 at Hyderabad

7.3 Paper Presentations

Following five research papers were presented (Oral) at 53rd Annual Convention of Indian Society of Agricultural Engineers (ISAE) - 2019 held during January 28-30, 2019 at BHU, Varanasi.

1. “Performance evaluation of roller and saw ginning technologies for fibre attributes of long staple cotton cultivars” by Dr. S. K. Shukla, Principal Scientist.
2. “Effect of single locking of cotton bolls on ginning performance of Double Roller gin” by Dr. V. G. Arude, Senior Scientist.
3. “Rheological characterization of nanocellulose for suitability as a food additive” by Dr. Archana Mahapatra, Scientist.
4. “Rapid extraction of cottonseed oil using ultrasound assisted technique” by Er. Jyoti Dhakane-Lad, Scientist.
5. “Development of starch – polyvinyl alcohol (S/P) biodegradable composite film” by Dr. Sharmila Patil, Scientist.
8. A paper entitled “Establishment of Agro-processing Industries in view of start-up India-stand up India” authored by Dr. Dattatreya M. Kadam, P.G. Patil, P.S. Deshmukh and V.G. Arude was presented on 12-4-2019, in International Conference on “Role of Agricultural Engineering toward Global Food Security” organized under the aegis of Agricultural Engineering Division Board, IEI, Kolkata held at Bengaluru from 11-13 April, 2019.
9. A paper entitled “Application of Nanotechnology in Food Processing and Packaging” authored by Dr. Dattatreya M Kadam was presented in session on Food Process Engineering on 13th April, 2019 in International Conference on “Role of Agricultural Engineering toward Global Food Security”
10. Beater Mechanism for Arecanut (*Areca catechu L.*) Husk Fibre Production authored by P.S. Deshmukh, P.G. Patil, P. U. Shahare, J. S. Dhekale, G.B. Bhanage, V. G. Arude, A. K. Bharimalla and S.V. Ghadge, presented in

National Seminar on Fibre Resource management for Sustainable Development held at ICAR-National Institute of Natural Fibre Engineering and Technology (NINFET) during February 2-3, 2019

11. Development of Needle Drum Type Mechanism for Arecanut (areca catechu L.) Husk Fibre Separation authored by P.S. Deshmukh, P.G. Patil, P. U. Shahare, J. S. Dhekale, G.B. Bhanage, V. G. Arude, A. K. Bharimalla and D. M. Kadam, presented in National Seminar on Fibre Resource management for Sustainable Development held at ICAR-National Institute of Natural Fibre Engineering and Technology (NINFET) during February 2-3, 2019

Following research papers were presented in National level seminar on Value addition to crop residue on Natural Fibres, jointly organised by Indian fibre society and ICAR-Central Institute for Research on Cotton Technology on 4th December 2019.

12. T. Senthilkumar M. Murugesan, S. Dinesh, G. Krishna Prasad, P. G. Patil, "Modification of cotton ball Cuticle derived activated Carbon for removal of Reactive dye"
13. V. Mageshwaran*, Varsha Satankar, S.K. Shukla and P. G. Patil "Value-addition to cotton crop residues by fermentation technology"
14. S. K. Shukla, V. G. Arude, P. G. Patil, V. Mageshwaran, A. S. M. Raja, S. V. Ghadge and D. U. Patil "Process Optimization for Preparation of Cotton Stalk Pellets".
15. Manoj Kumar, Jayashree Potkule, Sujata Saxena and P.G. Patil "Valorization of crop residues from major and under-utilized fibre crops of India"

16. S V Ghadge, S K Shukla, P G Patil, V G Arude and D U Patil "Appropriate Logistics for Supply of Cotton Stalk Biomass for Preparation of Briquettes, Pellets and Other Value-Added Products"

7.4 Booklets

1. C. Sundaramoorthy, V G Arude, S K Shukla, A K Bharimalla, P S Deshmukh, V Mageshwaran, "ICAR-CIRCOT Value Addition Technologies on Cotton By-Products for Eastern and Southern Africa", Booklet Published by ICAR-CIRCOT

7.5 Conference Proceedings/ Souvenirs

1. T. Senthilkumar presented the part of research work of "Development of activated carbon from chemically modified cotton stalk" presented in Conference on Carbon Materials 2019 jointly organized by Indian carbon society and CSIR-National Physical Laboratory, New Delhi at India habitat centre, New Delhi during 20-22nd November 2019.
2. Sujata Saxena, P.G. Patil & Charlene P. D'Souza (2019) Future Prospects of Cottonseed/Cottonseed meal for Food and Feed purposes in Book of Background papers, *Cottonseed, Oil & Meal Conclave 2019* organised by SEA & AICOSCA on 23rd and 24th March 2019 at Hyderabad
3. Sujata Saxena, A.S.M. Raja & A. Arputharaj (2019) Environment Friendly Developments in Chemical Processing of Cotton Textiles, (Abstract) in Souvenir cum Abstracts book, *National Conference on Recent Advances in Physical Sciences* organized by International Academy of Physical Sciences & Kamladevi Rathi College, Rajnandgaon, (C.G.) on 18th & 19th Nov, 2019 at Rajnandgaon

The following papers published in Book of Papers, National Conference on Value Addition

to Crop Residues of Natural Fibres organized by ICAR- CIRCOT and Indian Fibre Society, Mumbai on 4th Dec, 2019 at Mumbai

4. T. Senthilkumar M. Murugesan, S. Dinesh, G. Krishna Prasad, P. G. Patil, "Modification of cotton ball Cuticle derived activated Carbon for removal of Reactive dye"
5. V. Mageshwaran*, Varsha Satankar, S.K. Shukla and P. G. Patil "Value-addition to cotton crop residues by fermentation technology"
6. S. K. Shukla, V. G. Arude, P. G. Patil, V. Mageshwaran, A. S. M. Raja, S. V. Ghadge and D. U. Patil "Process Optimization for Preparation of Cotton Stalk Pellets".
7. Manoj Kumar, Jayashree Potkule, Sujata Saxena and P.G. Patil "Valorization of crop residues from major and under-utilized fibre crops of India"
8. S V Ghadge, S K Shukla, P G Patil, V G Arude and D U Patil "Appropriate Logistics for Supply of Cotton Stalk Biomass for Preparation of Briquettes, Pellets and Other Value-Added Products"

7.6 Popular Articles

1. Jyoti Dhakane- Lad, Abhijit Kar, Manjit Lad, Archana Mahapatra, Sharmila Patil and D. M. Kadam. "न्यूनतम प्रसंस्कृत फल एवं सब्जियों के लिए खाद्य आवरण का उपयोग" प्रसंस्करण प्रगति, Half yearly Rajbhasha Magazine, Vol 2. July- December, 2017, ICAR-CIPHET, Ludhiana.
2. P. Vashist, S. Basak and S. W. Ali, Green flame retardants- Keeping out fires, Popular Science Magazine, NISCAIR-CSIR 2019, Vol-56, No-6, 25-27

7.7 Newspaper Articles

1. Article authored by Dr. P. G. Patil, Dr. V. G. Arude, Dr. S.K. Shukla, Dr. P. S. Deshmukh on "कापूस पर्हाट्यांपासून ब्रिकेट, पेलेट निर्मितीचे फायदे " (Benefits of briquettes and pellets from Cotton stalk) was published in a Marathi Newspaper 'AgroOne' on 26th July 2019

7.8 Other Publications

1. Annual Report 2018-19 (English)
2. Technological Report for the season 2018-19 of AICRP on cotton
3. Leaflet "ICAR-CIRCOT Green Crematorium"
4. ICAR-CIRCOT leaflet no: 186/2019 "Workshop on promoting Cotton by-Products in Eastern and Southern Africa under the aegis of United Nations Conference on Trade and Development"
5. Brochure in Hindi "ICAR-CIRCOT - Ruprekha"
6. Technology on Oyster mushroom cultivation using cotton stalks (Brochure)
7. ICAR-CIRCOT Eco-friendly Salt Free Dyeing Technology (Brochure)
8. ICAR-CIRCOT Value Addition Technologies on Cotton By-Products for Eastern and Southern Asia (Brochure)
9. Agripreneurship Orientation Programme (Uday)
10. Seed Stage Funding as Grant-in-aid to Startups (Ankur)
11. Training Leaflets
 1. Spinning of Technical Yarn and Quality Management

- ii. Double Roller Ginning Technology & Basics of Cotton Grading
 - iii. Quality Evaluation of Cotton
 - iv. Value addition to Cottonseed
 - v. Absorbent Cotton Technology
 - vi. Quality Evaluation & Spinning Performance of Indian Cottons using Advanced Techniques
 - vii. Basic and Advanced statistical Techniques for Research
 - viii. Applications of Nanotechnology
 - ix. Basic & Advanced Tech for Evaluation of Textile Material
 - x. Knitting & knit Garments
 - xi. Characterization of Material Using X-Ray Diffractometer (XRD)
 - xii. Spectroscopic and Chromatographic Techniques for material characterisation
 - xiii. Fibre Reinforced Composite
 - xiv. Instrumental Evaluation of Clothing Comfort
 - xv. Pulp, Paper & green packaging Technology
12. Training Manuals
- i. Absorbent Cotton Technology (2019)
 - ii. Applications of Nanotechnology (2019)
 - iii. Knitting & knit Garments (2019)
 - iv. Value addition to Cottonseed (2019)
13. Flyers
- i. Cotton Blended T-Shirt: A product of ICAR-CIRCOT
 - ii. ICAR-CIRCOT Green Crematorium
14. Flyers under RKVY-RAFTAAR
- i. Cotton Processing (Uday)
 - ii. Value addition to mango based agri-residue (Uday)
 - iii. Cotton Picker (Uday)
 - iv. Multipurpose Farm Equipment (Uday)
 - v. Eco-friendly finishing of Khadi fabric (Uday)
 - vi. Naturally rubber based garden pots (Ankur)
 - vii. Cost effective and accurate Lysimeter (Ankur)
 - viii. Value addition to agri-biomass (Ankur)
 - ix. Innovative paper carry bags (Ankur)
 - x. Herbal tea products (Ankur-flyer)
 - xi. Chemical free ginger and turmeric oil extraction (Ankur)
 - xii. Preservative free spices mix with extended shelf life (Ankur)
 - xiii. Innovative integrated farming (Ankur)
 - xiv. Real time temperature monitoring device for reefer containers (Ankur-flyer)
 - xv. Nano finished sleeping bags (Ankur)

8. IMC, RAC and IRC Meetings

8.1 Institute Management Committee (IMC)

The Seventy Eighth meeting of the Institute Management Committee (IMC) was held on July 09, 2019 under the chairmanship of Dr. P. G. Patil at ICAR-CIRCOT, Mumbai. The following members were present in the meeting.

- Dr. Abhijit Kar, IARI, New Delhi
- Dr. G. Balasubramani, CICR, Nagpur
- Dr. Vilas Kharche, DR, PDKV, Akola
- Smt. K. S. Somvanshi
- Shri Sunil Kumar, Member Secretary

Some of the members could not attend the meeting due to some preoccupation and were granted leave of absence by the IMC. In the beginning, the detailed account of research achievements of the institute were presented.

The committee also visited various divisions of the institute.

The documentaries prepared on “Naturally coloured cotton products” and the “Green Crematorium” were shown to the committee. The minutes of the 77th IMC meeting held on 12th April, 2018 was approved by the committee. New items purchased during 2017-18 and 2018-19 and the progress of the Works under the Institute budget head were reviewed. The committee expressed their satisfaction over the progress made in the settlement of audit paras. The meeting ended with vote of thanks by the member secretary.



8.2 XXV Research Advisory Committee (RAC)

The 25th Research Advisory committee meeting was held during 26-27 February, 2019 in the Conference room to review the progress of research. Dr. Nawab Ali, Chairman, RAC presided over the meeting. Members of RAC Dr. G. S. Nadiger, Former Director of Laboratories, Textile Committee, Mumbai, Dr. Narendra G Shah, Professor, Centre for Technology

Alternatives for Rural Areas, IIT, Mumbai, Dr. B. K. Behera, Head, Department of Textile Technology, IIT, New Delhi, Dr. Debasis Nag, Former Director, NIRJAFT and Dr. S. N. Jha, ADG (PE), ICAR were present. Members of the Institute Management committee Shri D. B. Sawale Patil, and Smt. K. S. Somvanshi also attended the meeting.



Dr. P. G. Patil, Director presented the overall achievements of the institute in his welcome speech. Action Taken Report on 24th RAC proceedings and the progress of research projects during the current year were presented. The committee deliberated on the work being done and provided inputs and directions for future course of research.

A publication in Hindi “ICAR-CIRCOT - Rooprekha” was released by the RAC chairman and members.



A MoU was signed between ICAR-CIRCOT and M/s. Plantebase Ventures Pvt. Ltd., Mumbai for “Development of starch based film for packaging” during the XXV RAC meeting.

8.3 Institute Research Council (IRC)

119th Annual Institute Research Council Meeting

119th Annual Institute Research Council Meeting was conducted on 25 April, 2019 to review the progress of research work carried out during April 2018 – March 2019. Dr. P. G. Patil, Director, ICAR-CIRCOT chaired the sessions. Dr. M. K. Sharma, whole time Director & CEO, Bajaj Steel Industries Limited, Nagpur, Dr. A. J. Shaikh, former Director of ICAR-CIRCOT, Dr. R. P. Nachane, former head, QEID. ICAR-CIRCOT and Dr. P. V. Varadarajan, Retired principal scientist CBPD ICAR-CIRCOT attended the meeting as experts. The meeting was attended by Heads of Divisions, Scientists and Technical Officers (ACTO and above).

Dr.P.G.Patil, Director CIRCOT and Chairman IRC welcomed all the expert members to the IRC. He briefly highlighted the achievements of the Institute in the last one year. He projected the trends in the Indian cotton sector and the scope for the extra-long staple cotton in the country. He highlighted the issues pertaining to the BIS standards for cotton quality, bale standardization, Industry 4.0 etc., and urged the scientist to tune their research with the present day needs and emerging scenarios. The progress of research for the Institute funded and externally funded projects were presented by the concerned Principal Investigators.



Dr. M.K. Sharma appreciated the activity of the institute and suggested that the research activity should also focus on removal of contamination from seed cotton, efficient delinting process, effect of duration and condition of the cottonseed storage on quality and standardization of cotton bales. He also urged that the training programme on Saw ginning technology to be started at GTC as there is lot of potential to attract the trainees from Africa and even from developed countries. For this necessary infrastructure to be created at GTC, Nagpur. Dr. A.J. Shaikh appreciated for covering diversified areas in the research programmes, Dr. R.P. Nachane suggested that the institute should capitalize on its capability and attract more externally funded projects and consultancy projects. Dr. P. Varadarajan in his remarks hinted that few basic research programme should be initiated. In the concluding remarks, Dr. P.G. Patil, Director and Chairman IRC, appreciated the contribution of the scientist in research, skill development activities & consultancy services and urged the scientist to apply for individual awards. He asked the scientist to link their research goals with the Sustainable Development Goals of the UN, so that the research output benefit the masses.

Half-yearly IRC

The meeting of half-yearly IRC was held under the chairmanship of Dr. P. G. Patil, Director, ICAR-CIRCOT Mumbai on 22nd October 2019. All the HoDs, Scientists and Technical staff attended this meeting. Dr. P. G. Patil in his opening remarks, emphasized the need to initiate projects using the advantages of recent methodologies like artificial intelligence, machine learning etc. in the cotton sector. Also, he mentioned about the status of surplus cotton in India (2019) and hence asked Scientists to come up with proposals to utilize the excess cotton in non-conventional areas by innovative ways. In line with the ICAR's agenda, Director told to work on the project proposals that are innovative, inclusive, affordable to community, development oriented and disruptive in addition to helping the farming community. During the meeting, progress of the various on-going projects were discussed. This was followed by detailed presentation on the project proposals by all the Scientists of the Institute, for inclusion in the upcoming five year plan (SFC) during 2020-2025. In his closing remarks, Director insisted to conclude every projects with tangible outputs so that the technology developed can benefit all the stakeholders and enhance the income of the farmers. Dr. A.S.M. Raja, Principal Scientist & In-charge, PME welcomed all the Scientists for this half-yearly IRC and vote of thanks was delivered by Dr. N. Vigneshwaran, Principal Scientist & PME nodal officer.



9. Participation in Seminars / Conferences / Meetings / Workshops

Scientists and technical staff of the institute attend the seminars / symposia / workshops / conferences at national as well as international level to present their research work and keep them abreast of the latest developments in their specific areas. Their participation in such

events and publication of proceedings / abstracts results in wider dissemination of the institute activities. The staff members presents their work and shares experience and knowledge gained during the visit with fellow colleagues through a formal presentation.

Table 9.1 Participation in conferences during 2019

Name of the Conference	Organizer / Venue	Date	Participants
International Textile Conference on "Textile 4.0" Second Edition	The Textile Association (India), Mumbai Unit	February 07, 2019	Dr. Sujata Saxena Dr. D. M. Kadam Dr. A.S.M. Raja Dr. N. Vigneshwaran Dr. A.K. Bharimalla Dr. P. K. Mandhyan Dr. C. Sundaramoorthy Dr. V.G. Arude
Standards Conclave on Moving forward with INSS - Developing a World Class Quality Ecosystem	FICCI, BIS & Export Inspection Council	February 08-09, 2019	Dr. Sujata Saxena
First International Conference on Entrepreneurship in Agriculture and Renewable Energy Sector	Dr. PDKV, Akola	March 15-16, 2019	Dr. C. Sundaramoorthy
International Conference on "Role of Agricultural Engineering towards Global Food Security" [Part of the Centenary Celebrations of IEI]	Agricultural Engineering Division Board, IEI, Kolkata IEI, Bengaluru	April 11-13, 2019	Dr. D. M. Kadam

Name of the Conference	Organizer / Venue	Date	Participants
TeXExcel 2019, Business Conclave on Textile 4.0 Competitiveness of Indian Textile & Apparel Industry – Forging Ahead	CII Mumbai	June 06, 2019	Dr. Sujata Saxena
Global Organic Convention - 2019	Nagpur	September 15-17, 2019	Dr. P.K. Mandhyan Dr. A. Arputhraj
National Conference of Agricultural Librarian & Users Community (NCALUC-2019) on Roll of Agricultural Libraries in the Network Digital Environment	Navsari Agricultural University Gujarat	September 25-27, 2019	Smt. Medha Kamle
“Cotton India 2019” conference	Akola	October 18-19, 2019	Dr. S. K. Shukla
Conference on Carbon Materials-2019	Indian carbon society & CSIR-National Physical Laboratory, New Delhi India habitat centre, New delhi	November 20-22, 2019	Dr. T. Senthilkumar
National Conference on Recent Advances in Physical Sciences	International Academy of Physical Sciences and Kamladevi Rathi Girls PG College, Rajnandgaon (C.G.)	November 18-19, 2019	Dr Sujata Saxena,
National Conference cum Workshop on “ Doubling Farmers Income: Strategies for Rainfed Agriculture”	MANAGE, Hyderabad	November 18-19, 2019	Dr. C. Sundaramoorthy

Name of the Conference	Organizer / Venue	Date	Participants
National Conference on Value Addition to Crop Residues of Natural Fibres	ICAR- CIRCOT and Indian Fibre Society, Mumbai at Mumbai	December 04, 2019	Dr Sujata Saxena Dr. D. M. Kadam Dr. A. S. M. Raja Dr. S. K. Shukla Dr. A. K. Bharimalla Dr. N. Vigneshwaran Dr. P. K. Mandhyan Dr. C. Sundaramoorthy Dr. V. G. Arude Dr. P. S. Deshmukh Dr. S. V. Ghadge Dr. T. Senthilkumar Dr. V. Mageshwaran Dr. A. Arputharaj Dr. Santanu Basak Dr. Manoj Kumar Er. Jyoti Dhakane Dr. Kirti Jalgaonkar Dr. Manoj Kumar Mahawar

Table 9.2 Participation in Seminars / symposia

Title	Organizer / Venue	Date	Participants
53 rd Annual Convention of ISAE & International Symposium on Engineering Technologies for Precision & Climate Smart Agriculture	Institute of Agricultural Sciences, Banarus Hindu University, Varanasi	January 28-30, 2019	Dr. V. G. Arude Dr. S. K. Shukla Smt. Jyoti Dhakane Lad Dr. Sharmila Patil Dr. Archana Mahapatra
National Seminar on Natural Fibre Resource Management for Sustainable Development	The Indian Natural Fibre Society in Collaboration with ICAR-NINFET, Kolkata	February 02-03, 2019	Dr. A. S. M. Raja Dr. P. S. Deshmukh
Seminar on HPTLC-MS and LC-MS-MS, Technique, Development and Applications	M/s Shimadzu and M/s Anchrom, Mumbai	December 05, 2019	Dr. Sujata Saxena

Table 9.3 Workshops / Meetings attended

Title	Organizer / Venue	Date	Participants
Training Workshop on "Extraction and Isolation of Phytoconstituent"	ICT, Mumbai	February 09-10, 2019	Dr. Santanu Basak
Brain Storming Workshop on Cotton Technology,	NASC, New Delhi	April 03, 2019	Dr. P. G. Patil
21 st meeting of Textiles Division Council, TXDC	Bureau of Indian Standards, Manak Bhavan, New Delhi	April 10, 2019	Dr. P. G. Patil
SAMARTH Workshop Theme: Partnership and Prosperity for All,	NASC Complex, New Delhi.	May 8-9th, 2019	Dr. A. K. Bharimalla
A review and planning workshop of SAMARTH organized by RKVY-RAFTAAR	New Delhi	November 18-20, 2019	Dr. A.K. Bharimalla Mr. Hemant Ladgaonkar,
4 th National workshop of Officers in-charge, Data Management (ICAR Research Data Repository for Knowledge Management)	NASC, New Delhi	December 10 - 11, 2019	Dr. M. V. Vivekanandan
Annual Group meeting of AICRP on cotton (south and central zone)	ANGRAU, Lam, Guntur, Andhra Pradesh.	May 30-31, 2019	Dr. P. K. Mandhyan, Dr. A. Arputharaj Shri K. Thiagarajan Shri S. Banerjee Shri Krishana Bara
Research and Recognition committee meeting of SNTD Womens' University, Mumbai	SNTD Womens' University, Mumbai	February 08, 2019	Dr. Sujata Saxena
Meeting of the BIS Sectional Committee TXD 05	BIS SASMIRA, Mumbai	February 28, 2019	Dr. Sujata Saxena
12 th meeting of BIS Textiles Speciality Chemicals and Dyestuffs sectional Committee, TXD 07 held on at	BIS, Manak Bhawan, New Delhi	April 10, 2019	Dr. Sujata Saxena

Title	Organizer / Venue	Date	Participants
Panel meeting of the Textile Speciality Chemicals and Dyestuffs Sectional committee TXD 07 of BIS to finalise the draft standards	BIS, ICAR- CIRCOT, Mumbai	May29. 2019	Dr. Sujata Saxena
47 th JOINT AGRESCO MEET 2019	MPKV, Rahuri and Maharashtra Council of Agricultural Education and Research, Pune	May 29-31, 2019	Dr. V. G. Arude
Meeting chaired by DG, ICAR, on collaborative research projects with IIT, Delhi,	New Delhi	July 31, 2019	Dr. P. S. Deshmukh
Meeting chaired by Economic Advisor, Ministry of Commerce, on World Cotton Day celebration	New Delhi	July 31, 2019	Dr. P. S. Deshmukh
13 th meeting of BIS Textiles Speciality Chemicals and Dyestuffs sectional committee TXD 07 held on at	BIS, Mumbai	September 16, 2019	Dr. Sujata Saxena
Meeting of experts for vetting of Kapas Praudyogiki Shabdavali, the English–Hindi glossary prepared by ICAR- CIRCOT, Mumbai	Scientific and Technical Shabdavali Aayog, New Delhi, ICAR-CIRCOT, Mumbai	September 17-19, 2019	Dr. Sujata Saxena
59 th AGM and awards function of All India Cottonseed Crushers Association (AICOSCA), Mumbai	All India Cottonseed Crushers Association (AICOSCA), Mumbai	September 24, 2019	Dr. Sujata Saxena
Brainstorming-cum-interaction meet on Mechanization of Cotton Harvesting	ICAR-CIAE, Bhopal	September 27, 2019	Dr. P. S. Deshmukh

Title	Organizer / Venue	Date	Participants
Experts meeting for vetting of Kapas Praudyogiki Shabdavali	Commission for Scientific and Technical Terminology, New Delhi	November 04-07, 2019	Dr. Sujata Saxena
Meeting to discuss on the Project design and implementation of Phase II of the Cotton Technical Assistance Programme (C-TAP)	Udyog Bhavan, New Delhi	November 13, 2019	Dr. P. G. Patil, Dr. C. Sundaramoorthy
Meeting of TXD 05 sub-committee of BIS	BIS, SASMIRA, Mumbai	November 29, 2019	Dr. Sujata Saxena

Director's participation in Major meetings / events

- Convocation Ceremony of Vithalrao Patil Mahavidyalaya (Shivaji University, Kolhapur), as Chief Guest on 16th March 2019 at Kale, Kolhapur (M.S.) and delivered Graduation Day (Convocation) Speech.
- Meeting with the officials of Bank Note Paper Mill (BNPM) regarding ICAR-CIRCOT paper pulp technology and security feature technology for currency paper production at Mysore on April 05, 2019 along with DDG (Engg.), ICAR & Dr. N. Vigneshwaran, *Principal Scientist, ICAR-CIRCOT.*
- Technical Assessment Panel of Export Inspection Agency, Mumbai, consisting Ms. Mamta Rani, Dy. Director, Export Inspection Agency, Mumbai (Min of Commerce & Industry, GOI), Dr. P. G. Patil, Director, CIRCOT & Dr. Dattatreya M. Kadam, Principal Scientist (APE) of CBPD visited M/s. General Mills India Pvt Ltd, MIDC Malegaon, Nashik on 20-06-2019 to certify their food products for export worthiness under Voluntary Certification Scheme.
- Attended the Meeting convened by the Hon'ble Minister of Textiles for the project presentation on Himalayan Fibres at Udyog Bhawan, New Delhi on 16.07.2019 with Dr. A.S.M. Raja, Principal scientist.
- Attended MoU signing ceremony between ICAR and MSME held on 21st August 2019 at NASC Complex, New Delhi along with Dr. A. K. Bharimalla, Head i/c TTD to showcase institute technologies on the occasion.
- Attended Global Organic Convention - 2019 on Natural Resource Management for sustainable Agriculture, Soil health & Quality Food, Dr. PDKV, akola at Nagpur (participated by Dr. P.G. Patil, Dr. P. K. Mandhyan and Dr. A. Arputharaj)

- ICAR Regional Committee-VII meeting held at ICAR-NBSS-LUP, Nagpur during 9-10 August 2019.
 - Meeting with Vice-Chancellor and other officials of Mahatma Phule Krishi Vidyapeeth, Rahuri regarding collaborative projects in nano fertilizers
 - Meeting on sharing experiences of EDP on "Developing Effective Organizational Leadership for Senior Officers of ICAR" at New Delhi under chairmanship of Secretary, DARE & DG, ICAR on 18th December 2019.
- Visits to Regional units and other Institutions**
- Visited Quality Evaluation Unit, Coimbatore on 28th February, 2019, for discussion with officials about progress of research activities and also inspected the work of Technical Staff working in the station and guided them for future work.
 - Visited the National Center for Nanosciences and Nanotechnology, University of Mumbai along with Dr. A.K. Bharimalla, Dr. N. Vigneshwaran, Dr. A. Arputharaj and Dr. Sharmila Patil on 4th July 2019 to discuss about the possible collaboration in the future areas of research.
 - Visited Tata Institute of Fundamental Research (TIFR), Colaba, Mumbai along with a team of scientists on 25th October 2019 for discussion on research collaboration in mutual areas of interest.
 - Attended 34th Convocation of Mahatma Phule Krishi Vidyapeeth (MPKV) on 5th December, 2019 at its Central Campus
 - Attended 10th Foundation Day of ICAR-Directorate of Floricultural Research, Pune on 10th December, 2019

10. Events Organized

Industry-Interface Meet

Interactive workshop with textile industries, Tiruppur

ICAR-CIRCOT in collaboration with Atal Incubation centre of NIFT TEA (AIC-NIFT TEA), Tiruppur, Tiruppur Exporters Association (TEA) and Dyers Association of Tiruppur (DAT), organized an interactive workshop on salt free dyeing technology on 1st March 2019 at Tiruppur. Tiruppur, a small town near Coimbatore, is a hub of knit processing industries with the annual turnover of Rs.40,000 crores comprising Rs.25,000 crore export and Rs.15,000 crore local market. Shri Raja Shanmugam, President, TEA, Shri. Bhopathi, CEO, DAT and Shri. S. Periasamy, CEO, AIC-NIFT-TEA graced the function and stressed the importance of adopting salt free dyeing technology for cotton due to the implementation of Zero Liquid Discharge (ZLD) based effluent treatment at Tiruppur. Dr. P.G. Patil, Director, ICAR- CIRCOT, briefed the

audience about various R & D works being carried out by the institute for the benefit of textile processing industries including salt free dyeing technology. Dr. A.S.M. Raja, Principal scientist of ICAR-CIRCOT made an elaborate presentation about the eco-friendly salt free dyeing technology developed by the institute and addressed the various technical queries raised by the participants. Dr. A. Arputharaj and Dr G. Krishna Prasad, Scientists presented on technologies developed by the institute such as antimicrobial finishing, mosquito repellent finishing, flame retardant finishing, naturally coloured cotton processing, calibration cotton etc. The interactive workshop had drawn good response with participation from nearly 70 industries from Tiruppur, Erode, Karur and Bengaluru.



Industrial Trial on Nanofinishing of cotton fabrics for sleeping bags

To impart antibacterial property to sleeping bags, the cotton fabrics lining need to be finished with antibacterial chemicals. About 100 m of navy blue coloured cotton fabrics (140

cm width, 125 GSM) were finished with ICAR-CIRCOT's Nano-ZnO finishing technology. This finishing was carried out in a commercial textile facility (M/s. Sabina Process, Asalpha, Sakinaka,

Mumbai) using a Jigger machine on 11th October 2019. The pre-finished fabric was soap washed followed by chemical treatments and

then, cured at 130 °C. The nanofinished fabrics will be analyzed for their properties and will be used to make sleeping bags.

Seminars / Workshops / Conference

International Workshop

An International Workshop was organised for African delegates under UN Development Account Project 1617K on “Promotion of Cotton by-products in Eastern and Southern Africa” implemented by United Nations Conference on Trade and Development (UNCTAD), Geneva during January 14-18, 2019. There were 16 African delegates representing Zambia, Zimbabwe and Uganda along with Mr. Thierry Kalonji, COMESA, Mr. Mathias Knappe, ITC, Mr. Kris Terauds & Stefan Csordas, UNCTAD.



The visit aimed at exposing the participants with India's experience in the cotton by-product value chain. The delegation was interested in the institute technologies such as briquetting & pelleting, degossypolization of cottonseed meal, mushroom cultivation and absorbent cotton production. Various industrial visits were organized in the five days training program. The delegates were taken to industries involved in the value chain such as Producers, processors and consumers and also machinery manufacturers.

A business meet was organized on 17 January, 2019 for interaction between the African delegates and value chain operators involved with cotton by-products in India. The machinery manufacturers, researchers, policy makers,

biomass briquettes and pellets producers, ginnerys, absorbent cotton producers and mushroom growers were invited under common platform in the business meet. Arrangements were made to have face to face interaction between the delegates and the industrialists. There were around 47 representatives from Industry.



National Conference

One day National Conference on “Value Addition to Crop Residues of Natural Fibres” was jointly organized by ICAR-Central Institute for Research on Cotton Technology, and Indian Fibre Society, Mumbai on 4th December, 2019 at ICAR-CIRCOT, Mumbai.

At the outset Dr. Sujata Saxena, Director In-charge, ICAR-CIRCOT welcomed the delegates & other dignitaries, Dr. R. P. Nachane, President IFS in his speech, briefed about the activities of the Indian Fibre Society and the relevance of the conference in the present context. Shri Suresh Kotak, Chairman Kotak & Co Pvt. Ltd was the Chief Guest of the inaugural function and Dr. B. M. Khadi, former Director, ICAR-CICR was the Guest of Honour. Dr. B. M. Khadi, in his address emphasized the importance of cost

benefit analysis in biomass utilization. He also narrated that the entrepreneurs & Start-ups who were attending this conference are lively example for underlying importance and business potential of the sector. Shri. Suresh Kotak, in his chief guest address, highlighted the gravity of the situation and need for effective utilization of the biomass generated in agricultural production system. He expressed his utmost satisfaction about the works being carried out at ICAR-CIRCOT since last 2 – 3 decades on value addition to the biomass.



There were three technical sessions with 20 presentations from researchers, scientist and entrepreneurs & start-ups. The first technical session had presentations from young entrepreneurs, start-ups and incubatees, who are involved in the business domain based on value addition to crop residues of cotton,

banana and rice husk etc. The other two technical sessions were based on research work in the value addition to the crop residues, one exclusively devoted to the cotton stalks and its application and the other technical session covered valorization of other natural fibres viz., jute, banana, kenaf, arecanut husk, and their industrial and textiles applications.

The conference after the due deliberation came out with the following recommendations: The researchers should ensure that the value addition should be economically sound and the developed product should be competent with the existing substitutes. It was also suggested that the overall benefit attributed to the environment through the biomass utilization should also be considered while computing the cost and benefit. There should be appropriate policy support for the promotion of the value added products developed from the crop residues (renewable resources) so as to create adequate demand in short term to nurture the sector. The policy initiative to promote the start-ups and entrepreneurship by creating apt environment for sustenance of the biomass value chain is the need of the hour, which can address the issues of employment generation, rural industrialization and additional income to the farmers.

Technology and Machinery Demonstration Mela – 2019

Ginning Training Centre of ICAR-CIRCOT, Nagpur organized a Technology and Machinery Demonstration Mela- 2019 on February 15, 2019. In this programme, more than one hundred cotton growing farmers from Wardha & Nagpur along with stakeholders from industries and research organizations participated.

An exhibition was also arranged to display the technology and machinery on cotton processing and by-products utilization for the farmers. Live demonstration on chipping of cotton stalks, preparation of bio-enriched compost, oyster mushroom cultivation and preparation of pellets were conducted for the benefit of farmers.



Lectures

Dr. V. Sundaram Memorial Lecture

ICAR-Central Institute for Research on Cotton Technology in collaboration with Indian Society for Cotton Improvement (ISCI) organised Dr. V. Sundaram Memorial Lecture on 19th February, 2019 at Jubilee Hall, ICAR-CIRCOT, Mumbai.



The lecture was delivered by Prof. Dr. Paul Teng, Chairman, ISAAA and MD, National Institute of Education, Nanyang Technological University, Singapore on the topic "Disruptive Technologies in Agriculture for the Next Green Revolution – with Special Focus on Cotton". Dr. K. P. Viswanatha, Vice-chancellor, MPKV, Rahuri was the Guest of Honour and Mr. D. Narain, Vice-Chairman and Managing Director, Bayer Crop Sciences, Mumbai presided over the function. About 110 delegates attended the lecture.

Lecture during RAC

Dr. Nareendra G. Shah, Professor, Centre for Technology Alternatives for Rural Areas

(CTARA), Indian Institute of Technology, Mumbai and member of RAC delivered a lecture on "Choosing a Research Problem and Delivering a Prototype Solution: Some Case Studies in Agro-process Engineering" on 27-02-2019 during the occasion of XXV RAC meeting.



Lecture series

ICAR-CIRCOT in collaboration with the Indian Fibre Society (IFS) has organised the following lectures on Wednesday, 22nd May, 2019 at 3.00 pm in the Jubilee Hall.

- Sustainable Flame Retardancy of Textile Materials by Shri Santanu Basak, Scientist
- The Outlook for Indian Natural Fibres amidst Global Uncertainties by Shri G. Chandrashekhar, Economic Advisor, Indian Merchant Chamber (IMC)
- Scientific and technical staff of the institute attended the lectures

Review Meetings

Annual Review of CRP – Natural Fibres

CRP on Natural Fibres (CRP- NF) is one of the platform projects approved under Agri-CRP by Indian Council of Agricultural Research (ICAR). ICAR-CIRCOT is the lead centre of the project for implementing CRP-NF project. The Agricultural Engineering SMD of ICAR has organized one day Annual Review Workshop for CRP on Natural Fibres on 15.03.2019 at College of Agricultural Engineering, Tamil Nadu Agricultural University (TNAU), Coimbatore under the chairmanship of Hon'ble DDG (Agri. Engineering) DR. K. Alagusundaram. Dr. S.N. Jha, ADG (PE) and Dr. B.S. Bisht, Former Vice Chancellor of GB Pant University of Agricultural and Technology chaired the Review workshop. Dr. A.S.M. Raja Principal Scientist and Lead Centre Project Co-coordinator (LC-PC) presented the overall progress of the project and also acted as Rapporteur for the session along with Dr. S.K. Shukla, Principal Scientist, ICAR-CIRCOT. Principle Investigators of all the projects from

lead as well as cooperating centres namely ICAR-NIRJAFT, Kolkata, Assam Agricultural University, Jorhat, Tamilnadu Agricultural University, Coimbatore participated in the workshop and presented their progress of their respective projects. Dr. S. N. Jha expressed his satisfaction about the overall progress of the project. Dr. B. S. Bisht in his concluding remarks asked all the PIs to incorporate principles like Artificial intelligence, Internet of things, robotics, nano and bio technologies while executing the research projects to meet the requirements of stake holders.



Accreditation

ISO 9001:2015 Surveillance Audit by BIS

Bureau of Indian Standards (BIS) has conducted a surveillance audit programme for the ISO 9001:2015 quality management system of the Institute during 5th and 6th of September 2019. Dr. (Mrs.) Vijay Malik, Scientist F and Head of BIS conducted the Audit. She audited CPBD, Admin, Engineering, PME cell and Top Management & MR functions for the effective implementation of ISO 9001:2015 accreditation. Based on the audit conducted by the way of verification of records and physical evidences collected,

interaction with the concerned officers and verification of system of internal audit and management review, the auditor concluded that institute is implementing documented quality management systems as per IS/ISO 9001:2015 effectively and also demonstrated the continual improvement in systems and processes. Dr. A.S.M. Raja, Management Representative of the ISO 9001:2015 QMS coordinated the audit programme.

Other Events

96th Foundation day

ICAR-CIRCOT, established in 1924, has completed nine and half decades of Research and Development activities contributing significantly to the segment of post-harvest processing of Cotton & other natural fibres and Value addition to their by-produce.

ICAR-CIRCOT celebrated its 96th Foundation day on 3rd December 2019. During this occasion, institute also celebrated 'Agricultural Education Day' to commemorate the birthday of first President of Independent India and first Union Minister of Agriculture of India, Bharat Ratna, Dr. Rajendra Prasad.

Dr. P. G. Patil, Director of the institute welcomed the guests and presented CIRCOT's past achievements and future plan. Dr. M. M. Pandey, Former DDG (Agri. Engg.), ICAR, New Delhi presided over the function and distributed the prizes to medal winners. In his chief guest address, he appreciated the efforts taken by the Director and staff of the institute to achieve the different goals.

Dr. B. M. Khadi, Former Director, ICAR-CICR, Nagpur, Shri. Suresh Kotak, Chairman, Kotak & Co. Ltd, Mumbai, Dr. V. Kumar Senior Cotton researcher, Surat were the guest of honours of the celebration. Dr. S. Sreenivasan and Dr. A. J. Shaikh Former Directors of the institute were also present on the dais. Dr. A. Arputharaj, Scientist proposed the vote of the thanks of the function. A cultural programme was organized on this occasion.

73rd Independence Day

ICAR-CIRCOT Celebrated Independence Day on August 15, 2019 with flag hoisting. Director Dr. P. G. Patil addressed the gathering consisting of staff members and their family.



Communal Harmony week

Communal Harmony week was celebrated in the institute during 19-25 November 2019.

National Integrity pledge

National Integrity Pledge was administered to the staff by Dr. P. G. Patil, Director on 19th November, 2019.

Vigilance Awareness week

Vigilance Awareness Week observed during 28 October 2019 – 2 November 2019. Vigilance oath was administered to the staff by Dr. A. S. M. Raja, Director in-charge on 28 October 2019.



Closing of Vigilance awareness week was on 02 November, 2019. Lecture on "Integrity - a way of life" was delivered by Shri. Dyaneshwar Raibhan Wagh, Police Inspector, O/o Additional Commissioner of Police Protection & Security, Fort, Mumbai. All the staff members of the institute attended the event.



Constitution Day

ICAR-CIRCOT celebrated Constitution Day on 26th November, 2019. On this occasion, Dr. P. G. Patil, Director, ICAR-CIRCOT read out the Preamble to the Constitution of India which was repeated by all staff members.

National Unity Day

National Unity Day was observed on 31 October 2019. Dr. P. G. Patil, Director administered the National Unity Day pledge to the staff.

Sadbhavana Divas

Sadbhavana Divas was observed on 20 August, 2019 on the occasion of the birth anniversary of former Prime Minister Shri Rajiv Gandhi. Dr. P. G. Patil, Director administered the Sadbhavana day oath to the staff at 11.00 am in the Jubilee Hall of the Institute.

National productivity week

National productivity week was observed during 12-18 February, 2019 with the theme "Circular Economy for Productivity and Sustainability." On the occasion of National Productivity day a discussion on the topic "How one can contribute in improvement of the productivity of the Department and the Institute" was held at 4.00 pm on 18th February,

Celebration of 150th birth anniversary of Mahatma Gandhi

Head Quarter, Mumbai

A talk by Eminent Gandhian Dr. Chitra Redkar was arranged on 30th January 2019 as part of the series of events to commemorate 150th birth anniversary of Mahatma Gandhi.

2019 in the Jubilee Hall in which staff members expressed their views.

International Yoga day

On the occasion of fifth International Yoga Day, a Yoga workshop was organized in ICAR-CIRCOT, Mumbai on 21st June, 2019 in Dr. R.L.N. Iyengar Building of the Institute All staff members attended the workshop. Yogasanas were demonstrated by the teachers and instructors from Shri Ambika Yoga Kutir, Thane (Ghatkopar Branch). Shri. Sudhir Sawant, Sanchalak of Shri Ambika Yoga Kutir, Ghatkopar Branch briefed about the importance of Yoga. Yogasanas were performed by all the staff members under the guidance of instructors from Shri Ambika Yoga Kutir as per protocol from Ministry of Aysh, Government of India. Along with five demonstrators / instructors were present to guide all the staff members while performing Yogasanas. Dr. P.G. Patil, Director suggested & requested to Shri. Sudhir Sawant, Sanchalak, Shri Ambika Yoga Kutir, Ghatkopar Branch to conduct Yoga classes once in a week so that all the staff members can avail the benefit of the same.



Ambedkar Jayanti Celebration

Bharat Ratna Dr. B. R. Ambedkar's 128th birth anniversary was celebrated on April 15, 2019 in Jubilee Hall of ICAR-CIROT, Mumbai by initiative of Institute Joint Staff Committee

The copies of the book "My experience with Truth" by Mahatma Gandhi were distributed to the staff members of ICAR-CIRCOT and its regional units in eight languages viz. English (46), Hindi (41), Marathi (59), Tamil (6),

Kannada (1), Malayalam (1), Gujarati (1) and Urdu (1).

A quiz contest on Mahatma Gandhi was organized in ICAR-CIRCOT, Mumbai, on 24th July, 2019 in which all the staff members participated. Ms Pooja Tiwari, Assistant won the first prize, second prize was bagged by Shri C.M. More, ACTO and the third prize was shared by Shri D.U. Kamble, STO and Shri Prashant Gavale, Technical Assistant.

An essay competition was held in the institute on 26th July, 2019 in both Hindi and English. The topic of the competition was "Feasibility of Gandhian ideology in Modern India." A large number of the staff members participated in

the competition. The winners were Ms Himani Singh, Assistant 1st prize, Ms Pooja Tiwari, Assistant 2nd and 3rd prize went to Smt N. M. Deshmukh, Assistant

On the occasion of celebration of 150th birth anniversary of Mahatma Gandhi, a Prabhat Pheri from the Institute to nearby places and back was organized. The members of the staff from ICAR-CIRCOT, Mumbai, took an early morning walk holding banners and singing Mahatma Gandhi's favorite bhajans. Also under the program Swachh Bharat Abhiyan, removal of plastic waste from the nearby places was carried out to make the environment plastic free.



On the eve of Mahatma Gandhi's birthday a program was organized in ICAR-CIRCOT, Mumbai. After the welcome address by Dr D.M. Kadam, Principal Scientist officiating as the Director; events held during the period 2nd October, 2018 to 2019 were summarized by Shri Sunil Kumar, Sr. AO and Chairman of the Committee. Prizes were distributed by Dr. D.M.

Kadam to all the winners of various events organized during the year. Also, the canvas painting of Mahatma Gandhi painted by Dr. Shantanu Basak, Scientist and Mr. Sudhakar Chandanshive, Skilled supporting staff (winners of the drawing competition) was unveiled. The program ended with a film resonating Gandhian ideology.



Ginning Training Centre, Nagpur

Various events were organised by the Ginning Training Centre of ICAR-CIRCOT, Nagpur to commemorate the 150th birth anniversary of Mahatma Gandhi.

Ginning Training Centre, ICAR-CIRCOT, Nagpur organised a speech on “Mahatma Gandhi and Khadi” by Dr. Pramod Watkar, Professor and Head, Department of Gandhian Thoughts, Rashtra Sant Tukdoji Maharaj Nagpur University, Nagpur on August 26, 2019.

The program began with ICAR song, Dr. S. K. Shukla, Officer In-charge, GTC, Nagpur

welcomed Dr. Watkar by presenting a Rose sapling for plantation. Speaking on this occasion, Dr. Watkar said that Mahatma Gandhi advocated peace and non-violence during a period, which was mired by ultra-nationalism, gross inequalities, and brutalities on colonized societies.

ICAR-CIRCOT Ginning Training Centre, Nagpur conducted a visit to Sevagram, Wardha where Mahatma Gandhi had spent his life during his struggle for freedom. They collected the information on Mahatma Gandhi's life and his teaching and learnt about his simple life and great thoughts.

The Gandhi Jayanti was celebrated with great reverence on 2nd October, 2019 at GTC by organizing cleanliness drive in office premises and conducting elocution competition on “Mahatma Gandhi's Valuable Thoughts”. All GTC staff participated enthusiastically in the elocution competition.

International Women's day

The Institute celebrated International Women's day on March 08, 2019. On this occasion, Webcast of Hon'ble Prime Minister Shri Narendra Modiji addressing Women's Self-help Groups was viewed by the staff members.

Dr. P. G. Patil, Director, introduced the gathering about history of Women's Day celebration. He

emphasized on the role of women in history of India and the World. Staff members also expressed their views on the theme of the year "Think Equal, Build Smart, Innovate for Change" and the role of women in the overall development of the society. This was followed by poetry recital and speeches by the Women staff members of the institute.



Mahashramdaan



"Shri Sushil Kumar, I.A.S., Additional Secretary (DARE) & Secretary (ICAR) & Dr. J.P. Mishra, ADG (ICT) flagged-off a team of Jalmitra from the Institute for "Mahashramdaan Programme" of Paani Foundation to build the water conservation structures for the groundwater recharge in the drought prone village of Sawarde in Sangli District on 1st May 2019. A team of 15 CIRCOT staff visited the village and dug trenches for preservation of water during the coming rainy season.

Efforts taken by the Institute were appreciated by the Villagers, Volunteers of Paani Foundation, ICAR HQ, New Delhi. This event was sponsored by Indian society for Cotton Improvement (ISCI) and Agricultural Research Service Scientists' Forum of the Institute.

Awareness programmes

ICAR-CIRCOT in collaboration with Vivant Untamed Earth Foundation (a registered body and actively involved in the conservation of biodiversity and environment) had organised an awareness programme "An environment friendly path to fitness and adventure" on 10th August 2019. Under this programme, a talk by Dr. Anant Joshi (renowned orthopaedic and a cyclist), Mr. Hrushikesh Shende (a Film maker) was arranged to promote cycling as a way to fitness and protecting the environment. The event was attended by stalwarts, experts and members from various groups engaged in the same cause.



ICAR-CIRCOT in collaboration with Vivant UntamedEarth Foundation organized an event on 28th September, 2019 to spread awareness regarding conservation of Butterflies. A renowned lepidopterist Dr. Milind Bhakare delivered a lecture on the "Conservation of Butterflies". An exhibition, to display various species of butterflies, through butterfly paper art by Mr. Paresh Churi was held in the institute premises.



11. Hindi Implementation

11.1 Hindi Pakhwada

Hindi Fortnight was celebrated in the institute during 13–28 September, 2019. Shri Harish Pathak a notable writer and journalist was the chief guest at the inaugural ceremony of the Hindi fortnight on September 13, 2019. Shri Pathak expressed that Hindi language takes a person out of the darkness of ignorance into the light of knowledge. Hindi is a culture, a way of life, the language of a hundred crore people, has a history of a thousand years and is included in the 10 powerful languages of the world. Dr. P. G. Patil, director of the institute presided over the program. Dr. Patil said that today Hindi is also spoken in countries like Mauritius, Guyana and Suriname etc.

The closing ceremony of the fortnight took place on September 28, 2019. The Chief Guest of the function, Mr. Anil Tiwari, resident editor of “दोपहर का सामना” expressed that there are



GTC of ICAR-CIRCOT, Nagpur

Hindi Week celebrations were organized at the Ginning Training Centre, Nagpur. Inaugural program of Hindi week was on September 13, 2019 and Officer in-charge and Principal Scientist, Dr. S. K. Shukla lighted the lamp to inaugurate the event. In his speech, Dr. Shukla said that Hindi has its own importance. There is no simple language like Hindi, it is a competent language in itself. After independence, the

many countries in the world whose languages have become extinct. We are fortunate that our official language Hindi is continuously growing at a steady pace on every step of its development. Hindi language is the embodiment of humility, faith, worship, sentiment and spirituality, and hence Hindi is the fifth dham of India.

Dr. (Mrs.) Sujata Saxena, Director in-charge, in her welcome address, briefed about the achievements of Hindi implementation in the institute throughout the year. Dr. D. M. Kadam, Principal Scientist and Chairman of Hindi Fortnight Organizing Committee, presented a fortnightly report about various competitions organized during the fortnight. A total of 11 competitions were organized during the fortnight in which a total of 81 officers / employees of the institute actively participated.



Constituent Assembly has also given Hindi the status of official language. He appealed to all employees to carry out their work in Hindi. He briefed about Hindi competitions such as elocution, essay writing, technical words etc. to be held during the week at the centre. At the end of the program, all the employees of the Centre were congratulated on the occasion of Hindi Day.

On the occasion of Concluding Day of Hindi Week on September 20, 2019, Dr. Manoj Pandey, Senior Professor, Hindi Postgraduate Department, National University of Hindi, Nagpur was Chief Guest. Dr. Pandey highlighted the importance of Hindi language in the concluding speech said that Hindi is the language of communication and it transmits the human conscience. The Hindi language combines the culture values of India. Hindi combines the entire nation into one thread. It is our ultimate responsibility to use Hindi in our everyday work. People who speak different languages live in this country. We should respect the language of every person. Everyone knows, speaks and writes Hindi and it is a very easy language. All the languages spoken in the country have their own importance along with Hindi language. Common words of other languages should be included in the Hindi language. He inspired all the employees to work in Hindi.

Dr. S. V. Ghadge, Principal Scientist in his concluding speech gave a detailed account of the Hindi week organized at the centre and he said that the orders received from time to time related to Rajbhasha are followed and implemented in the centre. Training related to ginning, office work, correspondence etc. are carried out in Hindi language throughout the year. As a result, the centre has achieved the target set for Hindi correspondence. A total of 12 employees of the centre actively participated in various competitions. The cash prizes and certificates for the winning employees were handed over by the guest. Compering of opening and closing ceremony of Hindi week was done by Shri R. D. Shambharkar and Mr. DU Patil proposed the vote of thanks and expressed his gratitude to all the employees who have assisted in making the program a success.



11.2 Hindi Workshops

1. A Hindi workshop on scientific and technical writing in Hindi (हिंदी में वैज्ञानिक एवं तकनीकी लेखन) by Shri Virendra Kulkarni, Deputy Director (Official Language), Heavy Water Board, Department of Atomic Energy, Government of India, Anushaktinagar, Mumbai, was organized for scientific, technical and administrative staff of the institute on 16-03-2019 and a total of 68 officers / employees participated in the workshop.
2. Dr. Sushil Kumar Sharma, Member Secretary, Narakas and Deputy General Manager (Official Language) Western Railway, Churchgate, Mumbai conducted the Hindi workshop on the subject of annual program goals and their compliance (वार्षिक कार्यक्रम के लक्ष्य और उनका अनुपालन) on June 29, 2019 for all scientific, technical and administrative officers / employees. A total of 68 officers / employees took advantage of this.

3. Quarterly Hindi Workshop for the period of July to September 2019 for the staff of the institute was held on 21 September, 2019. Dr. Mahendra Jain, Professor Hindi Teaching Scheme, CBD conducted the workshop on modernizing Hindi (हिंदी का आधुनिकीकरण) for all scientific, technical and administrative officers / employees. 64 officers / employees attended the workshop



Meetings of the Official Language Implementation Committee

A total of 4 meetings were held during the year on the following dates.

1. 20-02-2019
2. 09-05-2019
3. 20-08-2019
4. 03-12-2019

City Official Language Implementation Committee Meeting

The director of the institute, Dr. P.G. Patil attended the two half-yearly meetings organized by Nagar Official Language Implementation Committee, Mumbai.

1. Meeting on 27-05-2019
2. Meeting on 25-10-2019

Award

Dr. P. G. Patil, Director was conferred with the Ashirwad Rajbhasha Gaurav Samman, 2019 on September 20, 2019, during Ashirwad Golden

4. Dr. Anant Shrimali, Assistant Director, Hindi Teaching Scheme, gave a lecture on the topic "Hindi grammar - problem and solution" (हिन्दी व्याकरण समस्या और समाधान) on December 21, 2019, for all administrative officers / staff and skilled support staff, 27 officers / employees took advantage of the workshop.



Jubilee Celebrations, 2019 for the remarkable achievements of Official Language Implementation done by him in the Institute. The award was given by Honourable Union Minister Shri Arvind Savant, Ministry of Heavy Industries and Public Enterprises, Government of India.



12. Distinguished Visitors

Dr. Trilochan Mohapatra, Secretary, DARE and DG, ICAR

Dr. Trilochan Mohapatra, DG, ICAR, visited the institute on January 19, 2019. He interacted with all scientists and reviewed the progress of work.



Shri Sushil Kumar, Additional Secretary (DARE) & Secretary (ICAR)



Shri Sushil Kumar, Additional Secretary (DARE) & Secretary (ICAR) visited ICAR-CIRCOT, Mumbai on 1st May 2019. He visited the Research Laboratories and Nanocellulose Pilot Plant facility. Dr. P.G. Patil, Director, ICAR-

CIRCOT made a presentation about the institute activities highlighting the achievements in the research, skill development activities, Business incubation and commercial services.

Dr. K. Alagusundaram, DDG (Agri. Engg.), ICAR

Dr. K. Alagusundaram, DDG (Agri. Engg.), ICAR, New Delhi along with Dr. Ravindra Chary, Director, ICAR-CRIDA, Hyderabad visited GTC on

10th August 2019. DDG participated in the valedictory function of Rotobar ginning training.



Dr. S. N. Jha, ADG (PE), ICAR

Dr. S. N. Jha, ADG (PE), ICAR visited the Institute on 27 August, 2019. He attended the ABI review meeting and also reviewed Progress of all ongoing projects in the institute.



Shri. K Ramprasad, DGM (Plant - Incharge), M/s. BNPM, Mysuru



Shri. K Ramprasad, DGM (Plant - Incharge), M/s. Bank Note Paper Mill India Pvt. Ltd., Mysuru visited ICAR-CIRCOT, Mumbai on 31st May 2019.

Shri. Garjeet Singh, Manager (QA-Technical Control), Security Paper Mill, Hoshangabad

Shri. Garjeet Singh, Manager (QA-Technical Control), Security Paper Mill, Hoshangabad (MP) visited ICAR-CIRCOT, Mumbai on 15th June 2019 to see the facilities at the institute and to discuss about the R&D collaboration in areas of mutual interest.

Shri Abhishek Singh, Secretary, ASRB, New Delhi

Shri Abhishek Singh, Secretary, ASRB visited the institute on 20-07-2019 and interacted with the scientists.



13. SWACHH BHARAT ABHIYAN

The Prime Minister, Shri Narendra Modi, launched the **Swachh Bharat Abhiyan**, a nation-wide programme on 2nd October, 2014 to fulfil Mahatma Gandhi's vision of "Clean India". ICAR-CIRCOT, Mumbai is also making all efforts in implementing Swachh Bharat Mission of the Government of India. The various activities conducted during the year 2019 were as follows:

As a part of Swachh Bharat Abhiyan and as per the instructions received from the council, a campaign called "**Swachhta Hi Seva**" was launched in ICAR-CIRCOT, Mumbai and its regional stations from **15th September to 2nd October, 2019** by undertaking various activities like Swachhta pledge, organizing painting and essay competition, special drives on cleanliness and plastic free nation, etc. During the programme the following activities are carried out:

Sr. No.	Date	Activities carried out
1	11/09/2019	Display the Banners "Swachhta Hi Sewa" at appropriate places
2	12/09/2019	Conduct a cleaning programme in one of the Division in ICAR-CIRCOT premises (TTD)
3	13/09/2019	Awareness about Swachhta Hi Sewa programme to staff members
4	14/09/2019	Arranging cleaning drive/ awareness in Mahim Staff Quarters
5	15/09/2019	Arranging cleaning drive/ awareness in Ghatkopar Staff Quarters (Karpasa)
6	16/09/2019	Conduct a cleaning programme in one of the Division in ICAR-CIRCOT premises (MPD)
7	17/09/2019	Conduct a cleaning programme in one of the Division in ICAR-CIRCOT premises (QEID)
8	18/09/2019	Conduct a cleaning programme in ADMN section in ICAR-CIRCOT premises
9	19/09/2019	Conduct a cleaning programme in one of the regional unit of ICAR-CIRCOT (GTC, Nagpur)
10	20/09/2019	Conduct a cleaning programme in one of the Division in ICAR-CIRCOT premises (TTD)
11	21/09/2019	Conduct a cleaning programme in one of the regional unit of ICAR-CIRCOT (Coimbatore)
12	22/09/2019	Arranging cleaning drive/ awareness in Ghatkopar Staff Quarters (Param)

Sr. No.	Date	Activities carried out
13	23/09/2019	Conduct a cleaning programme in ADMN section in ICAR-CIRCOT premises
14	24/09/2019	Conduct a cleaning programme in one of the Division in ICAR-CIRCOT premises (QEID)
15	25/09/2019	Conduct a cleaning programme in one of the Division in ICAR-CIRCOT premises (CBPD)
16	26/09/2019	Conduct a cleaning programme in one of the Division in ICAR-CIRCOT premises (MPD)
17	27/09/2019	Conduct a cleaning programme in one of the Division in ICAR-CIRCOT premises (TTD)
18	28/09/2019	Collection of plastic waste in ICAR-CIRCOT premises
19	29/09/2019	Arranging cleaning drive/ awareness in Mahim Staff Quarters
20	30/09/2019	Conduct a cleaning programme in one of the regional unit of ICAR-CIRCOT (GTC, Nagpur)
21	01/10/2019	Conduct a cleaning programme in one of the regional unit of ICAR-CIRCOT (Surat)
22	02/10/2019	Arranging cleaning drive/ awareness in nearby area of ICAR-CIRCOT, Mumbai

A major cleanliness drive was arranged at **Matunga, Mumbai**. The staff of ICAR-CIRCOT, Mumbai carried out cleaning work inside and in surrounding area of Five Garden, a famous tourist spot situated at Matunga, Mumbai on **October 02, 2019**. The staff of ICAR-CIRCOT assembled at the designated place and gathered all garbage, polypropylene materials from inside and outside the garden. Thereafter, the entire garden area was thoroughly swept and cleaned. All the collected garbage were

placed in dust bins for proper disposal.

Similarly, as a part of the implementation of the Swachh Bharat Mission and the instructions received from Council a **“Swachhta Pakhwada”** was organized in all Divisions/Sections and Regional Units of the Institute of ICAR-CIRCOT, Mumbai from 16th December to 31st December, 2019. During the programme the following activities were carried out:

Sr. No.	Date	Activities carried out
1	16-12-2019	Display of Banner at prominent places, taking Swachhta pledge, Stock taking and briefing of the activities to be organized during the Pakhwada, plantation of trees.

Sr. No.	Date	Activities carried out
2	17-12-2019	Basic maintenance: Stock taking on digitization of office records/e-office implementation. Cleanliness drive including cleaning of offices, corridors and premises. Review of progress on weeding out old records, disposing of old and obsolete furniture's, junk materials and white washing/painting.
3	18-12-2019	<u>Sanitation and SWM</u> Cleanliness and sanitation drive within campus and surroundings including residential colonies, common market places. Stock taking of biodegradable and non-biodegradable waste disposal status and providing on the spot solutions.
4	19-12-2019	<u>Sanitation and SWM</u> Cleanliness and sanitation drive in the villages adopted under the Mera Gaon Mera Gaurav programme or other schemes by ICAR Institutes/KVKs involving village community. Reviewing the progress of ongoing Swachhta activities including implementation of SAP & providing at the spot solutions.
5	20-12-2019	Stock taking of waste management and other activities including utilization of organic wastes/generation of wealth from waste, polythene free status, composting of kitchen and home waste materials, promoting clean and green technologies and organic farming practices in kitchen gardens of residential colonies/one nearby village and providing on the spot technology solution.
6	21-12-2019	Campaign on cleaning of sewerage and water lines, awareness of recycling of waste water, water harvesting for agriculture/horticulture application/ kitchen gardens in residential colonies/1-2 nearby villages.
7	22-12-2019	Organising Workshops, exhibitions, technology demonstrations on agricultural technologies for conversion of waste to wealth, safe disposal of all kinds of waste. Debate on Swachhta at the DARE/ICAR establishments, Seminars, awareness camps, rallies, street plays and expert talks.
8	23-12-2019	Celebration of Special Day – Kisan Diwas (Farmer's Day) 23 December inviting farmers. Experience sharing on Swachhta initiatives by farmers and civil society officials. Felicitating farmers/civil society officials for exemplary initiatives of Swachhta.
9	24-12-2019	Swachhta Awareness at local level (organizing Sanitation Campaigns involving and with the help of farmers, farm women and village youth in new villages not adopted by any Institutes/ establishments.

Sr. No.	Date	Activities carried out
10	25-12-2019	Cleaning of public places, community market places and/or nearby tourist spots.
11	26-12-2019	Fostering healthy competition: Organising competition and rewarding best offices/residential areas/campuses on cleanliness, Quiz, essay & drawing competitions for school children, village youth
12	27-12-2019	Awareness on waste management and other activities including utilization of organic wastes/generation of wealth from waste, polythene free status, composting of kitchen and home waste materials, Promoting clean and green technologies and organic farming practices in community places and on the spot redressal of issues.
13	28-12-2019	Campaign on cleaning of sewerage & waste lines, awareness on recycling of waste water, water harvesting for agriculture/horticulture application/ kitchen gardens in residential colonies outside campuses/nearby villages with the involvement of local/village communities.
14	29-12-2019	Visits of community waste disposal sites/compost pits, cleaning and creating awareness on treatment and safe disposal of bio-degradable/non-bio-degradable wastes by involving civil/farming community.
15	30-12-2019	Involvement of VIP/VVIP in the Swachhta activities, Involvement of print and electronic media may be ensured so that adequate publicity is given to the Swachhta Pakhwada.
16	31-12-2019	Organization of press conference of highlighting the activities of Swachh Bharat Pakhwada by involving all stake holders including farmers/VIPs/press and electronic media.

On this occasion, on the first day, Director administrated the oath to all the staff to maintain cleanliness of their working places and residential premises. During this period, a special cleanliness drive was arranged in the Veer Abhimanyu Udyan, Mahim Mumbai which is a tourist spot. In total, 17 cleanliness drives were covered during the pakhawada. All the staff members of ICAR-CIRCOT, Mumbai participated enthusiastically in all the cleaning programmes.

Similarly, an awareness program on 'waste management, utilization of organic waste, generation of wealth from waste, composting of waste material, promoting clean and green technologies and organic farming practices' was conducted in Anji village, Wardha district by GTC, Nagpur. The program was organised as part of the swachhta pakhwara (16-31 December 2019) and 'Mera Gaon Mera Gaurav' scheme. About 30 farmers from the village attended the program in the gram panchayat office premises.

In addition to all these activities, the committee conducted cleanliness programme in the various divisions of the institute as listed below:

Sr. No.	Date	Division Participated in the Swachh Bharat Abhiyan
1	20/2/2019	QEID
2	19/7/2019	QEID
3	22/8/2019	QEID
4	20/11/2019	MPD



Display of Banner at ICAR-CIRCOT



Director administered oath to maintain cleanliness



Cleaning programme inside the office premises



Cleaning programme at public places



Involvement of school children in Swachhta Abhiyan



Cleaning programme at staff quarters premises



Swachhta awareness programme conducted by GTC, Nagpur

14. MERA GAON MERA GAURAV

This report pertains to the progress of the fifth year of the *Mera Gaon Mera Gaurav* (MGMG) programme being implemented by ICAR-CIRCOT in 30 villages of Wardha district in Vidarbha region of Maharashtra for the benefit of cotton growing farmers. Six teams comprising of 3-4 scientists in each group were formed for implementation of the MGMG programme in the adopted villages. Detailed action plans and programmes were formulated based on the experience gained in the previous years for sustainable cotton production and doubling farm income. Scientists and technical experts regularly interacted with farmers, organized awareness programmes, field and technology demonstrations, kisan gothis/meets, skill development and knowledge enhancement programmes. In addition, the interaction of experts of other research institutes and organizations were also arranged for providing crop specific package of practices to the farmers. Thus, a linkage was created between farmers and research institutes, NGOs, state departments and industry.

In 2019, ICAR-CIRCOT conducted 12 village visits, interface meetings, demonstrations and awareness programs in which about 1451 farmers from the adopted villages participated. Latest technologies, processes and products of ICAR-CIRCOT and other organizations were showcased and other farming related issues were discussed during these programmes. Various production, harvesting, processing and value addition issues including cotton adulteration and contamination were addressed during the interactions and discussions. In addition, farmers were apprised about various central and state govt schemes such as Crop Insurance, Clean India Mission, Pradhan Mantri Ujjwala Yojana and Right to Education.

The deterioration of cotton quality parameters during harvesting and storage, particularly at farmers place is a major concern to the textile industry that affects the cotton pricing and farm income, negatively. It is observed based on interaction with the farmers that awareness about quality issues in marketing and pricing of cotton is least among villagers. ICAR-CIRCOT scientists arranged a number of kisan gothis, field visits and interactions with different stakeholders including ginners and spinners for creating awareness among farmers for adopting proper harvesting and storage practices. The farmers were also educated about proper packing and transportation practices for avoiding mixing of contaminants in the cotton. In 2019, ICAR-CIRCOT organised a Mega Awareness Programme in association with The Confederation of Indian Textile Industry-Cotton Development and Research Association (CITI-CDRA) at district Wardha for creating awareness among farmers related to quality issues and marketing of cotton based on its quality parameters. In this programme, over 500 farmers and other stakeholders from all 30 MGMG villages participated.

A Technology and Machinery Demonstration Mela-2019 was organized at GTC, Nagpur to showcase latest technologies, machinery and products on cotton processing & by-product utilization, especially for MGMG farmers. Live demonstrations on preparation of bio-enriched compost, pellets, particle board and oyster mushroom cultivation using cotton stalks and assessment of ginning out turn, moisture content and fibre attributes, etc. were also arranged for the benefit of farmers. On this occasion, an exhibition was also organised, in which the latest technologies and processes for value addition of cotton stalks were exhibited by various stakeholders. On this occasion, 10 progressive farmers from MGMG villages were felicitated.

In order to promote lint-based marketing of cotton, ICAR-CIRCOT in association with APMC, Hinganghat and Agro-plus Foundation, Nagpur launched the first of its kind “Centre for Determination of Ginning Percentage (GP)” which was inaugurated by Shri Sudhir Kothari, Chairman, APMC, Hinganghat in presence of CIRCOT team of scientists and representatives of several stakeholders including hundreds of farmers on December 31, 2019 in the premises

of APMC market yard at Hinganghat. ICAR-CIRCOT has given 3 lab model gins to APMC, Hinganghat for determination of GP on pilot basis. This new initiative shall help to get the right price for seed cotton not only on the basis of weight but also the quality in terms of lint percent. It will also compel the breeders and seed companies to market varieties/hybrids having higher GP.



Launching of Ginning Percentage Determination Centre at APMC, Hinganghat





Mera Gaon Mera Gaurav Activities in Wardha district during the year 2019

15. Infrastructural Facilities

The Institute is well equipped with state-of-art research and testing facilities for conducting research in post-harvest processing of cotton and allied fibres.

Some of the facilities available in the Institute include

- ❖ **Fibre, Yarn and Fabric Testing Laboratory** (With High Volume Instrument and Advanced Fibre Information System): The laboratory has all the instruments for analysing the quality parameters of the Cotton and other fibres, yarn and fabrics. Besides research, this service is also provided to the Traders and other stakeholders in the cotton value chain.
- ❖ **Nanocellulose Pilot Plant Facility:** Capacity to produce 10 kg of Nanocellulose per day (Facility first of its kind in India): Service extended to Research organizations, Industrial stakeholders for carrying out studies on application of nanocellulose.
- ❖ Other Unique research and instrumentation facility available at the institute include Scanning Electron Microscopy (SEM); DREF Spinning Machines; Kawabata Evaluation System (KES); Atomic Force Microscopy (AFM); Thermo Gravimetric Analyser; Fourier Transformation Infrared Spectrometer; Atomic Absorption Spectrometer; Ultra High Pressure Homogenizer; Nano particle size analyser; Gas Chromatography with Mass Spectrometer:
 - ❖ Electrospinning Facility
 - ❖ Computerised sample Weaving Facility
 - ❖ Composite Lab facility
 - ❖ Modern Ginning and Pressing Plant
 - ❖ Cottonseed Processing Plant
 - ❖ Particle Board Manufacturing Plant: One tonne per day production capacity plant is established in Nagpur. The facility is used by Incubatees to undertake scale up trials.
 - ❖ Pelleting Plant



High Volume Instrument



Administrative Hall with Modular Furnishing



Total Organic Carbon Analyser



Sample Applicator for HPTLC



Trash analyser



Lea Tester



Temperature and
RH Maintaining System



Semi-Automatic sheet former



Smart Energy Meter

Annexure 1

Ongoing Research Projects

Institute Funded Projects

S. No.	Title	Investigators	Duration
Core Area I: Pre - Ginning and Ginning			
1	Development of an Efficient system for processing of kawadi cotton in ginneries	S. V. Ghadge (PI)	2018-20
2	Development of Trash Handling System for Control of Pink Bollworm in Cotton Ginneries	V. G. Arude (PI) Dattatreya M Kadam P. S. Deshmukh C. Sundaramoorthy S. K. Shukla	2018-20
3	Development of a Rotary Tubular Drum Dryer for Quarantine of Pink Bollworm infested Cottonseeds in Ginneries	S. K. Shukla (PI) V. G. Arude V. Mageshwaran Archana Mahapatra	2018-20
Core Area II: Mechanical Processing, Technical Textiles and Composites			
4	Development of Activated Carbon Based Protective Mask	T. Senthilkumar (PI) G. Krishna Prasad A. S. M. Raja	2018-20
5	Development of High Performance Cotton Pads for Wound Dressing	G. Krishna Prasad (PI) N. Vigneshwaran T. Senthilkumar A. S. M. Raja	2018-20
6	Development of Cotton Based Smart Fabric for Warm Pads and Garments	P. Jagajanantha (PI) Sharmila Patil G. Krishna Prasad P. K. Mandhyan	2018-20
7	Development of Composite Material based Sanitary C Pad	Dattatreya M Kadam (PI) P. Jagajanantha	2018-20

S. No.	Title	Investigators	Duration
Core Area III: Characterisation of Cotton and other Natural Fibres, Yarns and Textiles			
8	AICRP on Cotton (Quality Research)	P.K. Mandhyan (PI) A. Arputharaj P. Jagajanantha	2017-20
9	Development of Marker Fibres: A Tool for traceability of cotton textiles	A. Arputharaj (PI) P.K. Mandhyan G. Krishna Prasad A. S. M. Raja	2018-20
Core Area IV: Chemical and Biological Processing, Biomass and By-products Utilisation			
10	Scaleup of the microbial process for degossypolization and nutritive quality improvement in Cottonseed cake	V. Mageshwaran (PI) Manoj Kumar Dattatreya M Kadam	2018-20
11	Development of natural fibre based fragrance material for well-being	Santanu Basak (PI) A. S. M. Raja Sujata Saxena	2019-20
Core Area V: Entrepreneurship and Human Resource Development			
12	Development of Nanocellulose based Edible Coating for Fruits and Vegetables	Archana Mahapatra (PI) A. K. Bharimalla Manoj Kumar Jyoti Dhakane-Lad Sharmila Patil	2019-20

Externally Funded Projects

S. No.	Title(Funding Agency)	Investigators	Duration
1	Industrial Adoption of ICAR- CIRCOT Paper Pulp Technology (Extra Mural - ICAR)	N. Vigneshwaran (PI) Sujata Saxena A. S. M. Raja A. K. Bharimalla P. K. Mandhyan P. S. Deshmukh C. Sundaramoorthy A. Arputharaj	2018-20
2	Agri Business Incubation Centre at ICAR–CIRCOT, Mumbai (NAIF-Incubation Fund)	A. K. Bharimalla (PI) S. K. Shukla N. Vigneshwaran P. K. Mandhyan V. G. Arude C. Sundaramoorthy V. Mageshwaran	2015-20
3	An Inclusive Agribusiness Model for Sustainable Cotton Marketing in the State of Maharashtra (NASF)	C. Sundaramoorthy (PI) V. Mageshwaran G. Krishna Prasad	2018-21
4	Valorisation of Cottonseed Meal: Extraction of Quality Protein for improving the Livelihood of Cotton Farmers (DST)	Manoj Kumar (PI) Sujata Saxena	2019-20
5	Remunerative Approaches for Agriculture and Allied Sectors Rejuvenation (RAFTAAR)Agribusiness Incubation Centre (R-ABI) (DAC&FW)	A. K. Bharimalla (PI) C. Sundaramoorthy P. S. Deshmukh V. G. Arude P. K. Mandhyan N. Vigneshwaran Sharmila Patil S. K. Shukla V. Mageshwaran	2019-20

S. No.	Title(Funding Agency)	Investigators	Duration
Consortia Research Platform (CRP) on Natural Fibres			
6	Utilisation of Lignocellulosic Fibre based Biomass as Renewable Energy for Rural and Industrial Application	S. K. Shukla (PI) V. Mageshwaran S. V. Ghadge P. G. Patil A. S. M. Raja V. G. Arude	2015-20
7	Preparation of Micro/ Nanolignocellulose and its Incorporation in Molded Products for Improved Performance	N. Vigneshwaran (PI) A. K. Bharimalla C. Sundaramoorthy T. Senthilkumar Jyoti Dhakane	2015-20
8	Eco-friendly method of preparing absorbent/surgical cotton from non-spinnable cotton	P. Jagajanantha (PI) V. Mageshwaran	2015-20
9	Sustainable Green Technology for Dyeing of Cotton Textile	A. S. M. Raja (PI) Sujata Saxena A. Arputharaj T. Senthilkumar	2015-20
10	Value addition to banana pseudostem fibre	Jyoti Dhakane (PI) P. K. Mandhyan A. K. Bharimalla Sharmila Patil Archana Mahapatra	2018-20
11	Development of nanocellulose based polymer composites for packaging applications	Sharmila Patil (PI) N. Vigneshwaran Archana Mahapatra Jyoti Dhakane A. K. Bharimalla	2018-20

Annexure II

PERSONNEL

(As on December 31, 2019)

DIRECTOR

Dr. P. G. Patil

M. Tech. (P.H.E.), Ph.D. (Engg.), F.T.A., FISAE.

SCIENTIFIC STAFF

HQ, MUMBAI

PRINCIPAL SCIENTIST

- | | |
|--|---|
| 1. Dr. S. K. Chattopadhyay, M. Tech. (Text. MFG.), Ph.D. (Tex. Tech.), F.T.A., C. Engg., F.I.E., C. Text., F.T.I. (Manchester) | 4. Dr. A. S. M. Raja, M. Sc., Ph.D. (Textile Chemistry) |
| 2. Dr. (Smt.) Sujata Saxena, M.Sc., Ph.D. (Organic Chemistry) Head i/c, Chemical and Biochemical Processing Division | 5. Dr. P. K. Mandhyan, M.Sc., Ph.D., A.T.A (Tech. Textiles) Head i/c, Quality Evaluation and Improvement Division |
| 3. Dr. Dattatreya M. Kadam, M.Tech (ASPE), Ph.D | 6. Dr. N. Vigneshwaran, M.Sc. (Agri.), M.B.A., Ph.D. (Agricultural Microbiology) |

SENIOR SCIENTIST

- | | |
|---|--|
| 1. Dr. (Mrs.) Jyoti M. Nath, M.Sc., Ph.D. (Electronics & Instrumentation) | 3. Dr. P. S. Deshmukh, M. Tech., Ph.D., F.I.E. (Agril. Engg.) (Farm Machinery & Power) |
| 2. Dr. A. K. Bharimalla, M. Tech., Ph.D. (Composite) Head i/c, Technology Transfer Division | 4. Dr. C. Sundaramoorthy, M.Sc., Ph.D. (Agricultural Economics) |
| | 5. Dr. V. G. Arude, M. Tech. Ph.D. (Farm Machinery & Power) |

SCIENTIST

- | | |
|--|--|
| 1. Dr. A. Arputharaj, M.Sc., M. Tech., Ph.D. (Textile Chemistry) | 7. Dr. (Smt.) Sharmila Patil, M.Sc. (P.H.T.), Ph.D. (Agricultural Process Engineering) |
| 2. Dr. T. Senthilkumar, M. Tech., Ph.D. (Textile Manufacture) | 8. Dr. (Smt.) Archana Mahapatra, M.Tech., Ph.D. (Agricultural Process Engineering) |
| 3. Dr. G. Krishna Prasad, M. Tech., Ph.D. (Textile Tech.) | 9. Dr. Manoj Kumar, M.Sc., Ph.D. (Plant Biochemistry) |
| 4. Shri G. T. V. Prabu, M. Tech. (Textile Tech.) | 10. Er. (Smt.) Jyoti Dhakane-Lad, M.Sc. (PHT) |
| 5. Dr. Santanu Basak, M. Tech. Ph.D. (Textile Chemistry) | 11. Dr. Manoj Kumar Mahawar, M.Tech. Ph.D. (DPHT)(Agricultural Structures and Process Engineering) |
| 6. Dr. P. Jagajanantha, M. Tech., Ph.D. (Textile Tech.) | 12. Dr. Jalgaonkar Kirti Ramesh, M.Sc. (PHT), Ph.D., (Agricultural Structures and Process Engineering) |

GTC, NAGPUR**PRINCIPAL SCIENTIST**

- | | |
|---|---|
| 1. Dr. S. K. Shukla, M. Tech., Ph.D.
(Agricultural Process Engineering) Officer-
In-Charge, GTC | 2. Dr. S. V. Ghadge, M.E. (Ag.) M.B.A., Ph.D.
(Farm Machinery & Power) |
|---|---|

SCIENTIST

- | | |
|---|---|
| 1. Er. (Ms.) Varsha Satankar, M.Tech.
(Agricultural Structures and Process
Engineering)(On study leave) | 2. Dr. Kautkar Sheshrao Sakharam, M.Sc.
Ph.D. (Agricultural Structures and Process
Engineering) |
| | 3. Dr. K. Pandian, M.Sc. Ph.D.
(Agricultural Microbiology) |

TECHNICAL STAFF**HQ, MUMBAI****CHIEF TECHNICAL OFFICER**

- | | |
|---|---|
| 1. Dr. R. D. Nagarkar, M.Sc., Ph.D. | 6. Shri G. B. Hadge, M.Sc. |
| 2. Dr. (Smt.) Sheela Raj, M.Sc., Ph.D. | 7. Dr. M. V. Vivekanandan, M.Sc., Ph.D. |
| 3. Dr. (Smt.) Sudha Tiwari, M.Sc., Ph.D. | 8. Shri S. Banerjee, M.Sc. |
| 4. Dr. (Smt.) N. M. Ashtaputre, M.Sc., Ph. D. | 9. Shri B. R. Pawar, M. Sc., LL.M. |
| 5. Shri R. S. Prabhudesai, M.Sc., D.C.M. | 10. Shri R. K. Jadhav, M.Sc. |

ASSISTANT CHIEF TECHNICAL OFFICER

- | | |
|---|--|
| 1. Shri T. Venugopal, B.E. | 6. Shri P. N. Sahane, D.I.F.T. |
| 2. Shri C. M. More, M.Sc. | 7. Smt. P. S. Nirhali, M.Sc. |
| 3. Shri R. R. Chhagani, M.Sc. | 8. Shri S. V. Kokane, M.A. |
| 4. Shri H. S. Koli, M.Sc., LL.B. | 9. Er. Chandrika Ram, M. Tech. (APFE) (on
deputation) |
| 5. Dr. (Smt.) S. R. Kawlekar, M.Sc., P.I.M.R.,
Ph.D. | |

SENIOR TECHNICAL OFFICER

- | | |
|--------------------------------|--|
| 1. Shri K. Narayanan, B.Sc. | 5. Dr. (Ms.) C. P. D'Souza, M.Sc., Ph.D. |
| 2. Smt. Binu Sunil, M.Sc. | 6. Shri R. S. Narkar, M.Sc., D.C.I.A. |
| 3. Shri D. U. Kamble, B.Sc. | 7. Smt. P. R. Mhatre, B.Sc., M.Lib. |
| 4. Smt. Bindu Venugopal, M.Sc. | 8. Smt. C. D. Prabha, M.Sc. |

TECHNICAL OFFICER

- | | |
|-----------------------------------|---|
| 1. Shri V. D. Kalsekar, B.Sc. | 4. Shri N. D. Kambli, M.Sc. |
| 2. Shri M. G. Ambare, M.Sc. | 5. Shri D. M. Correia, I.T.I., N.C.T.V.T.
(Mechanic) |
| 3. Shri S. N. Patil, B.E. (Civil) | |

SENIOR TECHNICAL ASSISTANT

1. Smt. H. R. Pednekar, B.A., B.Lib.
2. Shri R. P. Kadam, M.Sc.
3. Smt. M. P. Kamble, B.A., M.Lib.
4. Shri A. R. Jadhav, B.Sc.
5. Shri Krishna Bara, D.H.T.

TECHNICAL ASSISTANT

1. Shri D. A. Salaskar, Driver
2. Shri P. P. Thakur
3. Shri P. G. Gavhale
4. Shri D. M. Raje
5. Shri R. R. Gosai

SENIOR TECHNICIAN

1. Shri Mahabir Singh
2. Shri S. V. Kokane, Driver
3. Shri M. M. Kadam
4. Shri S. G. Phalke
5. Shri D. J. Dhodia
6. Shri Yogesh Nagpure

GTC, NAGPUR**CHIEF TECHNICAL OFFICER**

1. Er. D. U. Patil, B. Tech. (Agril. Engg.)

ASSISTANT CHIEF TECHNICAL OFFICER

1. Shri U. D. Devikar, M.Sc.
2. Shri S. L. Bhanuse, M.Sc.
3. Shri S. N. Hedau, B.Sc.

SENIOR TECHNICAL OFFICER

1. Shri R. G. Dhakate, B.Sc.

TECHNICAL OFFICER

1. Shri C. V. Shivgan, Cert. Elec. Supr. PWD,
Cert. M. & A.W. Technician
2. Shri B.V. Shirsath, B.A., I.T.I

TECHNICAL ASSISTANT

1. Shri S. K. Parab, Cert. Cot. Spin.

QE UNIT, COIMBATORE

1. Shri S. Mukundan, M.Sc., Assistant Chief
Technical Officer
2. Shri M. Bhaskar, Dip. Ref. & Air-Cond.,
Technical Officer

QE UNIT, DHARWAD

1. Smt. V. G. Udikeri, M.Sc., Technical Officer

QE UNIT, GUNTUR

1. Shri K. Thiagarajan, M.Sc., Chief Technical
Officer

QE UNIT, SIRSA

1. Dr. Hamid Hasan, M.Sc., Ph.D.Chief
Technical Officer
2. Dr. Jal Singh, M.Sc., Ph.D.
Senior Technical Officer
3. Shri Umrao Meena
Senior Technician

QE UNIT, SURAT

1. Shri M. B. Patel, B.Sc., L.L.B, Senior Technical Officer

ADMINISTRATIVE STAFF**HQ, MUMBAI**

SR. ADMINISTRATIVE OFFICER: Shri Sunil Kumar, B.A. (Hons.)

ADMINISTRATIVE OFFICER: Smt. Sujata Koshy, B.Com.

FINANCE & ACCOUNTS OFFICER: Shri M. Radhakrishnan

ASSISTANT ADMINISTRATIVE OFFICER

1. Shri Y. R. Pathare, B.Sc., M.B.A.
2. Smt. T. P. Mokal, M.A.(Hindi)
3. Shri K. Parleshwar
4. Shri R. K. Pallewad, B.A.
5. Smt. N. M. Deshmukh, M.A., LL.B.

ASSISTANT FINANCE & ACCOUNTS OFFICER: Shri. S. V. Kasabe, B.Com, L.L.B.

ASSISTANT

1. Shri S. D. Ambolkar
2. Shri P. V. Jadhav
3. Kum. Pooja Tiwari, B.Sc.
4. Kum. Singh Himani Parmar, B.E.
5. Smt. S. P. Paiyala

UPPER DIVISION CLERK

1. Smt. S. G. Parab, B.A. (Sociology), B.A.
(Hindi)
2. Smt. J. R. Chavkute
3. Shri V. M. Sable
4. Smt. B. D. Kherodkar
5. Shri S. S. Angane
6. Shri T. D. Dhamange, B.Com.
7. Shri S. N. Bandre

LOWER DIVISION CLERK

1. Smt. V. N. Walzade, B.A
2. Shri S. N. Sahane
3. Shri Avinash Aman, B. Tech.

PRIVATE SECRETARY : Smt. S. D. Dudam, M.A

PERSONAL ASSISTANT

1. Smt. T. T. D'Souza
2. Smt. U. N. Bhandari

STENOGRAPHER

1. Smt. R. R. Tawde, B.Com.
2. Smt. V. R. Naik, B.A.

GTC, NAGPUR

ASSISTANT ADMINISTRATIVE OFFICER : Shri S. A. Telpande, M.Com

LOWER DIVISION CLERK : Shri R. G. Matel,

STENOGRAPHER : Shri R. D. Shambharkar, M.A.

SKILLED SUPPORT STAFF**HQ, MUMBAI**

1. Shri M. Z. Rathi
2. Shri M. A. A. Rashid
3. Shri M. J. Sumra
4. Shri K. T. Mahida
5. Shri H. B. Vesmiya
6. Shri M. M. Katpara
7. Shri S. K. Bobate
8. Shri P. P. Patil
9. Shri R. G. Tak
10. Shri R. P. Karkate
11. Shri S. B. Worlikar
12. Shri D. G. Gole
13. Shri M. K. Prabhulkar
14. Shri J. D. Sakpal
15. Shri V. Murugan
16. Shri S. D. Magar
17. Shri Sunil R. Tondse
18. Shri V. B. Poojari
19. Shri S. P. Naik
20. Shri M. N. Kamble
21. Smt. Kamala Murugan
22. Shri D. K. Kasar
23. Shri Suhas R. Tondse
24. Shri S. S. Surkule
25. Shri D. R. Gawde
26. Shri S. M. Chandanshive
27. Shri P. E. Gurav
28. Shri Mahesh C. Solanki
29. Shri Thapa Gorkha Bahadur Ovilal

GTC, NAGPUR

1. Shri R. B. Kautkar
2. Shri R. S. Umare
3. Smt. M. M. Bhandakkar

QE UNIT, COIMBATORE

1. Shri V. Subbaiah

QE UNIT, DHARWAD

1. Shri C. J. Bagalkoti
2. Shri A. F. Gudadur

QE UNIT, SURAT

1. Shri M. G. Sosa

PROMOTIONS

Dr. V. G. Arude designated as Senior Scientist w .e. f. January 03, 2019 on completion of his Ph.D

Sr. No.	Name of Staff	Grade to which Promoted	Effective Date of Promotion
1.	Dr. (Smt.) Sudha Tiwari	Chief Technical Officer	05-09-2016
2.	Dr. (Smt.) N. M. Ashtaputre	Chief Technical Officer	01-01-2017
3.	Shri R. S. Prabhudesai	Chief Technical Officer	01-01-2017
4.	Shri G. B. Hadge	Chief Technical Officer	01-01-2017
5.	Dr. M. V. Vivekanandan	Chief Technical Officer	01-01-2017
6.	Shri K Thiagarajan	Chief Technical Officer	01-01-2017
7.	Shri S. Banerjee	Chief Technical Officer	01-01-2017
8.	Shri B. R. Pawar	Chief Technical Officer	10-07-2017
9.	Shri R. K. Jadhav	Chief Technical Officer	18-12-2017
10.	Shri S. N. Hedau	Assistant Chief Technical Officer	23-03-2017
11.	Smt. S. R. Shirsat	Assistant Administrative Officer	24-01-2019
12.	Shri N.V. Kambli	Assistant Administrative Officer	01-04-2019
13.	Smt. N. M. Deshmukh	Assistant Administrative Officer	13-12-2019

DEPUTATION ABROAD

Name of Scientist	Name of the Programme	Place	Period
Dr. C. Sundaramoorthy, Senior Scientist	UNCTAD's Regional workshop on Promotion of cotton by-products in East and South Africa	Johannesburg, South Africa	May 28 – 30, 2019
Dr. P. G. Patil, Director	8th Meeting of the ICAC-Asian Cotton Research and Development Network (as chairman ACRDN 2018-19)	Tashkent, Uzbekistan	September 09-11, 2019
Dr. P. G. Patil, Director	"Executive Development Programme on Developing Effective Organizational Leadership for Senior Officers of ICAR (Foreign component)	Netherlands, Switzerland, Germany and Belgium	September 21-28, 2019
Dr. Sujata Saxena, Principal Scientist	Meetings of ISO TC 38 and its subcommittees (as an expert scientist member of BIS delegation)	Ponzano Veneto, Treviso, Italy	October 13- 18, 2019

Name of Scientist	Name of the Programme	Place	Period
Dr. S. K. Shukla, Principal Scientist	Training and supervising the operationalization of the ginning facility set up under "Knowledge Cluster-cum-Training centre" at INRAB, Bohicon, Benin under Cotton Technical Assistance Programme (TAP) implemented under aegis of 2nd India Africa Forum Summit.	Bohicon, Benin	September 23 – 29, 2019
Dr. Manoj Kumar, Scientist	Asian Cotton Research and Development Network meeting, 2019, organized by International Cotton Advisory Committee, USA	Tashkent, Uzbekistan	September 09-11, 2019

TRANSFERS

Scientists

Dr. Manoj Kumar Mahawar transferred from ICAR-CIPHET, Ludhiana joined ICAR-CIRCOT, Mumbai on December 02, 2019.

Dr. Kirti Ramesh Jalgaonkar transferred from ICAR-CIPHET, Ludhiana joined ICAR-CIRCOT, Mumbai on December 02, 2019.

Dr. Sheshrao Sakharam Kautkar transferred from ICAR-Indian Grassland & Fodder Research Institute joined GTC of ICAR-CIRCOT, Nagpur on December 19, 2019

Dr. K. Pandian transferred from ICAR-NBAIM, Mau (UP) joined GTC of ICAR-CIRCOT, Nagpur on December 26, 2019.

Dr. V. Mageshwaran transferred from GTC of ICAR-CIRCOT, Nagpur to ICAR-NBAIM, Mau (UP) relieved on December 19, 2019.

Administrative

Shri M. Radhakrishnan, Finance and Accounts Officer transferred from Sugarcane Breeding Institute, Coimbatore joined ICAR-CIRCOT, Mumbai on March 25, 2019

RESIGNATION

Kum. Nikky Shokeen, Assistant resigned from service on June 26, 2019

RETIREMENTS

Smt. V. V. Janaskar, Assistant Administrative Officer retired voluntarily from service w.e.f. January 02, 2019.

Smt. S. R. Shirsat, Assistant Administrative Officer superannuated on March 31, 2019.

Shri N.V. Kambli, Assistant Administrative Officer, superannuated on May 31, 2019.

Dr. S. Venkatakrishnan, Chief Technical Officer superannuated on May 31, 2019.

Shri M. A. A. Rashid, Skilled Supporting Staff superannuated on December 31, 2019.

OBITUARY

Shri. D. V. Kambli, retired Sr. Tech. Asst. expired on 29-06-2019

Dr. S. N. Pandey, former director expired on 04-07-2019

Dr. M. S. Parthasarathy, retired Principal Scientist expired on 21-12-2019

Annexure III

LIST OF COMMITTEES

Institute Management Committee (IMC)

Dr. P.G. Patil, Director, (Chairman)

Dr. S.N. Jha, ADG (PE), ICAR, New Delhi

Joint Director of Agriculture, Nagpur Division

Director (Agri.), Madhya Pradesh

Dr. V. Kharche, Associate Dean, Govt. Agriculture College, Dr. PDKV, Akola

Shri D. B. Sawale Patil, Buldana, Maharashtra

Smt. K. S. Somvanshi, Pune, Maharashtra

Dr. L. K. Nayak, ICAR- NINFET, Kolkata

Dr. Abhijit Kar, Principal Scientist, ICAR-IARI, New Delhi

Dr. G. Balasubramani, Principal Scientist, ICAR-CICR, Nagpur

Dr. (Smt.) Sujata Saxena, Principal Scientist, ICAR-CIRCOT, Mumbai

FAO, ICAR-CIRCOT, Mumbai

Shri Sunil Kumar, Sr. AO, Member Secretary

Research Advisory Committee (RAC) [2016-19]

Dr. Nawab Ali, Former DDG (Agril. Engg.), ICAR, (Chairman)

Dr. G.S. Nadiger, Research Advisor (SASMIRA) & Former Director (Textile Committee), Mumbai

Dr. A. Rakshit, Executive Director, Indian Technical Textiles Association, Mumbai

Dr. N. G. Shah, Professor, Centre for Technology Alternatives for Rural Areas, IIT, Mumbai

Dr. B. K. Behera, Professor & Head, Department of Textile Technology, IIT, Delhi

Dr. D. Nag, Former Director, NINFET, Kolkata

Dr. P.G. Patil, Director, ICAR-CIRCOT, Mumbai

Dr. S. N. Jha, ADG (PE), ICAR, New Delhi

Dr. V.G. Arude, in-charge PME Cell, Member-Secretary

Project Monitoring and Evaluation Committee (PMC)

Dr. P.G. Patil, Director, (Chairman)

Dr. (Smt.) Sujata Saxena, In-charge Head, CBPD

Dr. P.K. Mandhyan, In-charge Head, QEID

Dr. A.K. Bharimalla, In-charge Head, TTD

Dr. V.G. Arude, In-charge PME Cell, Member secretary (up to September 2019)

Dr. A.S. M. Raja, In-charge PME Cell, Member secretary (from October 2019)

Priority-setting, Monitoring & Evaluation (PME) Cell

Dr. V.G. Arude, Senior Scientist, In-charge (up to September 2019)

Dr. A. S. M. Raja, Principal Scientist, In-charge (from October 2019)

Dr. C. Sundaramoorthy, Sr. Scientist, Nodal Officer, PME(up to September 2019)

Dr. N. Vigneshwaran, Principal Scientist, Nodal Officer, PME, (from October 2019)

Shri K. Narayanan, STO

Smt. H. R. Pednekar, STA

Shri Anand R Jadhav, STA

Institute Technology Management Committee (ITMC)

Dr. P.G. Patil, Director, (Chairman)

Dr. P. K. Mandhyan, Principal Scientist, I/c. Head, QEID

Dr. A. S. M. Raja, Principal Scientist, CBPD

Dr. C. Sundaramoorthy, Senior Scientist, Member Secretary of IRC

Dr. B. B. Nayak, Principal Scientist, ICAR-CIFE, Mumbai

Dr. N. Vigneshwaran, Principal Scientist, CBPD

Dr. A.K. Bharimalla, In-charge ITMU, Member Secretary

Institute Technology Management Unit (ITMU)

Dr. A.K. Bharimalla, Sr. Scientist, In-charge

Dr. N. Vigneshwaran, Principal Scientist, CBPD

Dr. P.K. Mandhyan, Principal Scientist & Head In-charge, QEID

Dr. M.V. Vivekanandan, ACTO

Shri G.B. Hadge, ACTO

Institute Joint Staff Council

Dr. P.G. Patil, Director, (Chairman)

Dr. P.S. Deshmukh, Sr. Scientist, TTD

Shri Sunil Kumar, Senior Administrative Officer

Shri S. V. Kasabe, A. F & AO, Office side member

Dr. (Smt.) S. S. Patil, Scientist, Office side member

Shri B. R. Pawar, ACTO, Office side member

Mrs. Nandini Deshmukh, AAO, staff side member

Shri S. N. Patil, Technical Officer, staff side member

Shri C. V. Shivgan, TO, staff side member

Shri P.V. Jadhav, Assistant, CJSC Member

Shri M K Prabhulkar, Secretary, IJSC

Shri S. D. Magar, SSS, staff side member

Shri Y. Pathare, AAO, Member Secretary

Internal Complaints Committee

Dr. (Smt.) S. Saxena, Principal Scientist, In-charge Head, CBPD, (Chairperson)

Dr. P. K. Mandhyan, Principal Scientist, QEID

Dr. (Smt.) Archana Mahapatra, Scientist, TTD

Smt. S. Charankar, Principal, Dr. BNM College of Home Science, Mumbai

Smt. S. Koshy, AO

Smt. P. S. Nirhali, ACTO

Smt. P. R. Mhatre, STO, Member Secretary

Staff Welfare Fund Committee

Dr. P. K. Mandhyan, Principal Scientist, (Chairman)

Shri D. U. Kamble, STO

Shri S. V. Kasabe, (AF&AO)

Shri P. V. Jadhav, Assistant

Smt. Sujatha Koshy, AO, Member Secretary

ISO-9001:2015 Management Committee

Dr. P.G. Patil, Director, (Chairman)

Dr. (Smt.) S. Saxena, Principal Scientist, Head In-charge, CBPD

Dr. V.G. Arude, Senior Scientist, In-charge, PME Cell

Dr. P.K. Mandhyan, Principal Scientist, In-charge Head, QEID

Dr. A.K. Bharimalla, Senior Scientist, Head In-charge, TTD

Dr. A.S.M. Raja, Principal Scientist, Management Representative

Dr. A. Arputharaj, Scientist, QEID

Sr. Administrative officer

AF&AO

AO

Sports Committee

Dr. A.S.M. Raja, Principal Scientist, Chairman

Dr. C. Sundaramoorthy, Sr. Scientist

Shri. Sunil Kumar, Sr. A. O.

Shri. M. Radhakrishnan, FAO

Dr. R. D. Nagarkar, Chief Technical Officer

Smt. S. Paiyala, Assistant

Dr. Manoj Kumar, Scientist, Member Secretary

Purchase Committee

Dr. Sujata Saxena, Principal Scientist & in-charge Head CBPD, Chairman

Dr. A. K. Bharimalla, Senior Scientist & In-charge Head, TTD

Dr. T. Senthilkumar, Scientist, MPD

Shri S. Banerjee, CTO

Shri Sunil Kumar, Senior A.O

Shri. S. V. Kasabe, AFAO

Assistant Administrative Officer (Admn II), Member Secretary

Technical Evaluation Committee

Dr. A. S. M. Raja, Principal Scientist, (Chairman)

Dr. T. Senthilkumar, Scientist

Dr. P. Jagajantha, Scientist

Smt. Sujatha Koshy, AO, Member Secretary

Swachhata Mission Committee

Dr. P. G. Patil, Director, (Chairman)

Dr. A. S. M. Raja, Principal Scientist

Shri Sunil Kumar, Senior Administrative Officer

Shri S. V. Kasabe, AFAO

Shri Sharad V. Kokane, Security Officer

Dr. A. K. Bharimalla, Senior Scientist

Dr. G. Krishna Prasad, Scientist

Dr. Nishant D. Kambli, Technical Officer, Member Secretary

Rajbhasha Committee

Dr. P. G. Patil, Director, (Chairman)

Dr. (Smt.) S. Saxena, Principal Scientist & In-charge Head CBPD

Dr. P. K. Mandhyan, Principal Scientist

Dr. A. K. Bharimalla, Senior Scientist

Shri Sunil Kumar, Senior Administrative Officer

Smt. S. Koshy, AO

Dr. R. Uniyal, Deputy Director (Hindi), CIFE & Additional In-charge (Hindi), CIRCOT

Shri M. Radhakrishnan, FAO

Shri S. V. Kasabe, A F & AO

Smt. P. R. Mhatre, Senior Technical Officer

Shri Y. Pathare, AAO
Shri K. Parleshwar, AAO
Shri R. K. Pallewad, AAO
Smt. T. P. Mokal, AAO, Member Secretary

Works Committee

Dr. A. K. Bharimalla, Sr. Scientist & In-charge Head TTD, Chairman
Shri Sunil Kumar, Senior Administrative Officer
Dr. A. Arputharaj, Scientist
Shri B. R. Pawar, ACTO
Shri S. V. Kasabe, A. F & AO
Er. T. Venugopal, Officer in-charge Engg., Member Secretary

Test Fee Revision Committee

Dr. (Smt.) S. Saxena, Principal Scientist & In-charge Head, CBPD, (Chairperson)
Dr. P.K. Mandhyan, Principal Scientist and In-charge Head, QEID
Dr. A. K. Bharimalla, Senior Scientist and In-charge Head TTD
Dr. G. Krishna Prasad, Scientist, MPD
Shri B. R. Pawar, ACTO
Smt. P. S. Nirhali, ACTO, Member Secretary

Grievance Committee

Dr. P. G. Patil, Director, (Chairman)

Nominated Members

Dr. P. K. Mandhyan, Principal Scientist & In-charge Head, QEID
Shri Sunil Kumar, SAO
Shri S. V. Kasabe, AF&AO

Elected Members

Dr. P.S. Deshmukh, Senior Scientist (Scientific Category)
Shri B. R. Pawar, ACTO (Technical Category)
Smt. Smita P. Paiyala, UDC (Administrative Category)
Shri. Mahesh Solanki, S. S. S (Skilled Supporting Staff Category)
Shri. Y. R. Pathare, AAO, Member Secretary (nominated by Director)

Committee for celebrating 150th year of Mahatma Gandhi

Shri Sunil Kumar, Sr. AO (Chairman)

Er. Jyoti Dhakane-Lad, Scientist

Dr. (Smt.) Sujata Kawalekar, ACTO

Smt. Sujatha Koshi, AO

Shri K. Parleshwar, AAO, Member Secretary

ABI Advisory Committee

Dr. P. G. Patil, Director [Chairman]

Dr. R. P. Kachru, Former ADG (PE), ICAR, New Delhi

Dr. S. Sreenivasan, Former Director, ICAR-CIRCOT, Mumbai

Prof. Narendra Shah, CTARA, IIT, Mumbai

Dr. M. K. Sharma, Whole Time Director & CEO, Bajaj Steel Industries Limited, Nagpur

Dr. A. K. Bharimalla, Sr. Scientist, Principal Investigator: ICAR-CIRCOT-ABI Centre, Member-Secretary

RAFTAAR-Incubation Committee (RIC) Member of CIRCOT RABI

Dr. P. G. Patil, Director [Chairman]

Shri. B. B. Pradhan, Assistant General Manager (International Operations & NRI Business), Bank of Baroda, Mumbai

Dr. G. R. Anap, Former International Cotton Consultant, World Bank Project (Africa)

Prof. (Dr.) V. D. Gotmare, Former HOD, Textile Manufacture Department, VJTI, Mumbai

Prof. (Dr.) A. S. Vastrad, Professor and Dy. Director, Student Welfare, University of Agricultural Science (UAS), Dharwad

Shri. D. B. Bote, Joint Director Agriculture, Commissionerate of Agriculture, Pune

Mr. Ramesh. R Kadam, RTD, General Manager, Bank of India, Member (Representative of Bank)

Dr. Ashok K. Bharimalla, Senior Scientist, PI-CEO: CIRCOT-R-ABI, Member Secretary

CRP on Natural Fibres Project Implementation Unit

Dr. P. G. Patil, Director, Nodal Officer

Dr. A. S. M. Raja, Principal Scientist, Lead Centre Project Coordinator

Dr. C. Sundaramoorthy, Senior Scientist

Shri Sunil Kumar, Sr. AO

Shri M Radhakrishnan, FAO

Smt. Sujatha Koshi, AO

Shri S. V. Kasabe, AFAO



CITIZEN'S/CLIENT'S CHARTER

ICAR – Central Institute for Research on Cotton Technology
Adenwala Road, Matunga, Mumbai – 400 019
Phone: (022) 24127273/76, 24184274/75, Fax: (022) 24130835
Website: <http://www.circot.res.in>



VISION

Global Excellence in Cotton Technology

MISSION

To provide scientific and managerial interventions to post-harvest processing and value addition to cotton and other natural fibres and utilization of their by-products to maximize economic, environmental and societal benefits.

MAIN SERVICES/TRANSACTIONS

Sr. No.	Services/Transactions	Responsible Persons
1.	Commercial Testing: Fibre, Yarn, Fabric, Garment, Spinnability, Non-Lint Content, Linter, Seed, Paper, Board, Absorbent cotton, Chemical and Biochemical Tests of Textile Materials, ECO, SEM, XRD, etc.	Mrs. P.S. Nirhali Assistant Chief Technical Officer Incharge, Test House test.circot@icar.gov.in cottontest@rediff.com Phone Ext 456 / 457
2.	Imparting Training to Stakeholders	Dr. A.K. Bharimalla Technology Transfer Division ashokbhari72@gmail.com Phone Ext 467 and Dr. S.K. Shukla Ginning Training Centre, Nagpur skshukla2000@gmail.com Phone (0712) 2500592 , 2500289
3.	Supply of Calibration Cotton	Dr. P.K. Mandhyan Quality Evaluation and Improvement Division pkmandhyan@gmail.com Phone Ext 447
4.	Consultancy and Technology Transfer	Dr. A.K. Bharimalla Technology Transfer Division ashokbhari72@gmail.com Phone Ext 467

Public Grievance Officer

Shri Sunil Kumar, Senior Administrative officer
Phone: 022-24127627, E-mail sunkr2@rediffmail.com, Ext 138

For Further Information, Contact

Dr. P.G. Patil, Director, ICAR-CIRCOT, Mumbai



हमारा उद्देश्य

OUR MOTIVE

पारदर्शिता को बढ़ावा देने के लिए
To Promote Transparency

जवाबदेही को बढ़ावा देने के लिए
To Promote Accountability

सूचना का अधिकार अधिनियम, 2005 की घोषणा के अनुसरण में निम्नलिखित अधिकारियों को इस संस्थान में जनसूचना अधिकारी सहायक जनसूचना अधिकारी और अपीलीय प्राधिकारी के रूप में नामित किया गया है।

In Pursuance of the promulgation of Right to Information Act, 2005, the following Officers are designed as CPIO, Assistant CPIO and Appellate Authority at this Institute.

<p>केन्द्रीय लोक सूचना अधिकारी Central Public Information Officer श्री सुनील कुमार वरिष्ठ प्रशासनिक अधिकारी-भा. कृ. अनु. प.-के. क. प्रौ. अनु. सं. E-mail : director.circot@icar.gov.in : sunil.kumar@icar.gov.in Tel : 2412 7627 : 2412 7273 / 76, 2418 4274 / 75 FAX No. : 2413 0835 / 2415 7239</p>	<p>अपीलीय प्राधिकारी Appellate Authority डॉ. पी. जी. पाटील निदेशक-भा. कृ. अनु. प. - के. क. प्रौ. अनु. सं. E-mail : director.circot@icar.gov.in Tel : 2414 6002 : 2412 7273 / 76, 2418 4274 / 75 FAX No. : 2413 0835 / 2415 7239</p>
<p>सहायक केन्द्रीय लोक सूचना अधिकारी Assistant Central Public Information Officer श्रीमती. सुजाता कोशी प्रशासनिक अधिकारी-भा. कृ. अनु. प. - के. क. प्रौ. अनु. सं. E-mail : director.circot@icar.gov.in : sujata.koshy@icar.gov.in Tel : 2412 7273 / 76, 2418 4274 / 75 FAX No. : 2413 0835 / 2415 7239</p>	

ICAR-CIRCOT

Regional Stations





हर कदम, हर डगर
किसानों का हमसफर
भारतीय कृषि अनुसंधान परिषद
AgriSearch with a human touch



एक कदम स्वच्छता की ओर